



UCF Senior Design I

Distance-Monitored Inkless Laser Engraver (D-MILE)

*University of Central Florida
College of Electrical Engineering and Computer Science
The College of Optics and Photonics*

Dr. Aravinda Kar
Dr. Wei Lei
Dr. Samuel Richie

Group 4

Franklin Ivey
Computer Engineering
Ifran Tello
Electrical Engineering

Sean McCormack
Photonics Sciences and Engineering
Ethan Teodosio
Photonics Sciences and Engineering

Table of Contents:

1. Executive Summary	1
2. Project Description	2
2.1 Project Motivation	2
2.2 Goals and Objectives	3
2.2.1 Goals	3
2.2.2 Objectives	4
2.3 Requirements Specifications	4
2.4 House of Quality Analysis	5
2.5 Block Diagram	8
3. Project Research	10
3.1 Existing Similar Projects and Products	10
3.1.1 Xerox 9700	10
3.1.2 Computer Numerical Control Machines (CNC Machines)	11
3.1.3 Laser Powered Wood Engravers	12
3.1.4 Laser Inkless Printer (2021 Senior Design Project)	12
3.1.5 Laser Etching	13
3.6.2 Laser (Toner) Printers	14
3.2 Document Processing	14
3.2.1 Pre Existing Software	15
3.2.1.1 LaserGRBL	15
3.2.1.2 RasterCarve	16
3.2.1.3 ImageMagick	16
3.2.2 Proposed Custom Software	17
3.2.3 Software Comparison	17
3.3 Microcontroller System	18
3.3.1 ATmega family	19
3.3.2 MSP430 Family	20
3.3.3 STM32 Family	21
3.3.4 Family Comparison Conclusion	21
3.3.5 External Data Storage	22
3.3.5.1 SD cards	22
3.4 Laser System	23
3.4.1 Laser Type	23
3.4.1.1 Gas Laser	23

3.4.1.2 Fiber Laser	24
3.4.1.3 Laser Diode	24
3.4.1.4 Choosing the Laser Type	25
3.4.2 Beam Profile	25
3.4.3 Laser Power	27
3.4.4 Optical Setup	27
3.4.5 Optical Workspace Detection Method	28
3.4.6 Recap of Laser System	28
3.5 Fire detection System	29
3.5.1 Infrared Imaging	29
3.5.2 Spectroscopy	30
3.5.3 Bandstop Filter Sensors	30
3.5.4 Optical Fire Alarm	31
3.5.5 Fire Detection System Recap	32
3.6 Optical Distance Measurement	32
3.6.1 Visible Distance Sensor	33
3.6.2 Infrared Distance Sensor	34
3.6.3 Ultrasonic Distance sensor.	34
3.6.4 Optical Distance Measurement Recap	35
3.7 Movement and Control	35
3.7.1 Stepper Motors	35
3.7.2 Servo Motors	37
3.7.2.1 AC Servo Motors and DC Servo Motors	37
3.7.2.2 Brushed and Brushless Motors	38
3.7.3 Stepper Motors vs Servo Motors	38
3.7.4 Mechanical Axis Control	40
3.7.4.1 Threaded Rods	40
3.7.4.2 Timing Belts	41
3.7.4.3 Threaded Rods vs Timing Belts	41
3.7.4.4 Possible XY Axis Configurations	42
3.8 Possible Architectures and Related Diagrams	45
3.9 Part Selection Summary	46
3.9.1 Optical parts	46
3.9.2 Electrical Components	47
3.9.2.1 Voltage Regulator Integrated Circuits	47
3.9.2.2 Basic RLC Components	47
3.9.2.2.1 Diodes and LEDs	48
3.9.2.3 External Components	48

3.9.3 Microcontroller	49
3.9.4 Frame and Axis Control Parts	49
4. Related Standards and Design Constraints	50
4.1 IPC PCB Design Standards	50
4.1.1 IPC Product Classes	50
4.1.2 IPC-2221: Generic PCB Design	52
4.2 Laser Safety Standards	53
4.3 IEC Power Supply Safety Standards	55
4.3.1 IEC Protection Classes	55
4.4 Cost Constraints	56
4.5 Material Constraints	56
5. Project Hardware and Software Design Details	57
5.1 Overall Design Options	58
5.1.1 Laser Optical Design Options	59
5.1.1.1 Optical Design Used to Focus the Laser	59
5.1.1.2 Laser Power and How to Control it	59
5.1.1.3 Different types of lasers	60
5.1.2 Electrical Design Options	60
5.1.3 Computational Design Options	61
5.2 Laser Design	62
5.2.1 Focusing the Beam	62
5.3 Fire Safety Design	63
5.4 Other Optic Design Components	64
5.4.1 Optical Depth Measurement	65
5.4.2 Optical Workspace Detection	66
5.5 Hardware Design	70
5.5.1 PCB Design	70
5.5.1.2 High-Level Design Flowchart	70
5.5.1.3 Voltage Regulator Design Options	72
5.5.1.3.1 Voltage Divider as a Regulator	72
5.5.1.3.2 Zener Diode Regulator	73
5.5.1.3.3 LM317 Adjustable Voltage Regulator	74
5.5.1.3.4 LM2576 Adjustable Voltage Regulator	75
5.5.1.4 DC Fans	76
5.5.1.4.1 Laser Diode Driver DC Fan	77
5.5.1.4.2 Perpendicular PCB DC Fans	77
5.5.1.5 Indicator LEDs	77

5.5.1.6 Motor Driver and Stepper Motor Connections	79
5.5.1.7 Laser Diode and Driver Connection	79
5.5.1.8 Emergency/Master Switch	80
5.5.1.9 STM32 Microcontroller Connections	80
5.5.1.10 Distance Sensing System	81
5.5.1.11 External Connections	81
5.5.1.11.1 24V AC/DC Adapter	81
5.5.1.11.2 Mini-USB Connector	82
5.6 Software Design	82
5.6.1 MCU Firmware	82
5.6.1.1 Initialization	83
5.6.1.2 Printing Process	84
5.6.1.2.1 Controlling the Laser	85
5.6.1.2.2 Controlling the Stepper Motors	86
5.6.1.3 UART Interface	86
5.6.2 Document Processing Software	87
5.6.1 GUI	88
5.7 Frame and Axis Control	90
5.7.1 XY-Axis Gantry system	90
5.7.2 Z Direction Movement	91
3.7.3 Mechanical Frame Materials	91
6. Integration and Testing Plan	92
6.1 Hardware Test Environment	92
6.2 Hardware Specific Testing	92
6.2.1 Stepper/Servo Motor Test	92
6.2.2 PCB and Power Supply Testing	93
6.2.2.1 AC Power Adapter	93
6.2.2.2 General PCB Probing and Testing	93
6.2.2.3 Voltage Regulator Testing	94
6.2.2.3.1 LM317 12V Prototype	94
6.2.2.3.2 LM2576 12V Prototype	95
6.3 Laser Test Environment	96
6.3.1 First Laser Demo	96
6.3.1.1 Laser Demo Size Issue	98
6.3.1.2 Laser Demo Lens Design	98
6.3.2 Final Laser Demo	100
6.3.3 Final Laser Demo Results	107
6.4 Laser Specific Testing	109

6.4.1 Original Laser Pointer	109
6.4.2 Laser Module	109
6.4.3 The Second Laser Module	110
6.4.4 Lens Testing	110
6.5 Secondary Optical Design Test Environment	112
6.5.1 Fire Detection System Test Environment	112
6.5.2 Distance Sensing Test Environment	112
6.5.3 Secondary Laser Test Environment	112
6.6 Secondary Optical Design Specific Testing	113
6.6.1 Fire Detection System Testing	113
6.6.2 Distance Sensing Testing	113
6.6.3 Secondary Laser Testing	114
6.7 Software Test Environment	114
6.7.1 Document Processing Software Test Environment	114
6.7.2 MCU Firmware Test Environment	114
6.8 Software Specific Testing	115
6.8.1 Document Processing Software Testing	115
6.8.2 MCU Firmware Testing	116
7. Administrative Content	117
7.1 Milestone Discussion	117
7.2 Budget and Finance Discussion	119
7.3 Distribution of Work	120
8. Conclusion	122
9. References	123
List of Tables	123
List of Figures	123
Appendix A - References	124
Appendix B - Permissions	127

1. Executive Summary

Throughout history, printing has been an essential aspect of the world. Printing started with the use of stencils over 35,000 years ago. Over the generations, printing has evolved into laser printers and inkjet printers. Laser Inkless Printers are an upgrade to an ink printer in terms of resolution and sustainability. Ink is notoriously expensive, and has to be refilled manually. Most ink is petroleum-based, which means that ink contains inorganic compounds, heavy metals, and minerals, all of which are not biodegradable. As we look forward to a brighter and greener future, we must have a more environmentally friendly alternative to ink-based printing. Not only this, but ink bleeds away from the point of deployment by the printer itself. All of these factors are avoidable through the use of a laser for printing. By varying the power of a laser, you can create a laser that can print, engrave, burn or cut a variety of mediums such as paper, wood, or acrylic.

Distance-Monitored Inkless Laser Engraver (D-MILE) is a project based around creating a more ecological efficient printer. The goal is to reach a legible resolution that can print both grayscale images and text as a normal printer would, but without using any ink or toner. In addition to ecological benefits, the inkless and tonerless printing process will save the user money in the long run. D-MILE will be able to sit on a normal office table, and at a minimum will need to be able to print text in normal sized fonts, which we have decided on to be 12pt font. Because the project is attempting to supersede the use of a regular printer a user friendly interface is highly desired, and initiating printing should be as simple as sending a file to the printer, either directly or through a driver.

One of the main reasons we were so interested in taking this project on is due to the upkeep cost of ink. Not to mention that ink in most cases can be a hassle to replace and messy. This combined with the fact that ink is not biodegradable means that we have been putting lots of ink into our landfills that will never be cleaned. As we look into the future and plan to create more environmentally friendly products, printers should be near if not one of the first products to switch.

2. Project Description

Throughout this section we will discuss the project specification, engineering requirements and our motivation for creating this Distance-Monitored Inkless Laser Engraver (D-MILE). The engineering requirements will be discussed further within sections 3 and 4. We will also discuss our design requirements for our device.

2.1 Project Motivation

Groups in Senior Design have worked on this project before, and so our goal is to improve upon the performance of their design in two main categories. The primary goal is to move beyond a strictly braille printer into a continuous printing machine that operates just as a normal printer would. Our secondary goal is one of safety. Since we are dealing with paper and other flammable materials, the risk of a fire getting started is always looming. To combat this, we propose the use of a fire detection system that is capable of detecting if a fire would occur. Before printing, it would check for any smoke within the print area, and then during printing, it can be used for quality control and to ensure that there are no active hazards within the printing area. Many laser engravers are also difficult to set up and operate, our group strives to create a user-friendly system that is simple and intuitive. To aid in system operation, we propose an automatic adjustment feature of the printing bed height based on optical distance measurements. With this feature, the distance between the laser head and the target material can be kept constant without user interference. Groups in the past have also used pre-built manufactured printing mechanisms for moving the laser around. We hope to be able to create our own to help increase the efficiency and lower the overall cost of our build.

We'd also like to look into varying the optical power of the laser to change the utility of the printer to do more than just print on paper, but also potentially cut paper, engrave on wood or acrylic, or even cut wood, depending on time and budgetary restrictions. As well, if we could vary power we could print more than just monotone color with the laser, but expand to grayscale. This will give the consumers who are interested in printing on wood or other materials be able to purchase one printer for all of their needs. We realize our solution may be more expensive upfront however, we are aiming to create a printer with little to no maintenance and replacement of parts for multiple years. Ideally, this printer could be upgraded in the future to include any aspects of printing that may be missed due to budgetary restrictions. This would give the consumer the option to upgrade the printer as they see fit.

There are many motivations for D-MILE. One of the main motivations we have for this project is that this printer can be used instead of a regular ink based printer. Ink based printers can contribute to a significant amount of pollution within the world. With ink based printers you also must buy the ink and keep it in stock for when the printer inevitably runs out. This is important because ink tends to run out at the worst times and can be messy, time consuming, and expensive to replace.

We also were looking into the accessibility from the aspect of a blind person. Given that our printer will burn a hole in the paper, it will make an evident dent in the paper. This would let a blind person run their hand over the paper and be able to read the paper, kinda like a braille printer. This is something that we believe is not discussed that much and is a very important aspect that our printer will be able to do

Another motivation we have for this project is that it would allow you to print onto multiple pieces of paper at one time. We think this is important when you talk about printing a lot of papers at one time. The run time for the printer would be significantly less because it could print onto multiple papers saving overall print time.

2.2 Goals and Objectives

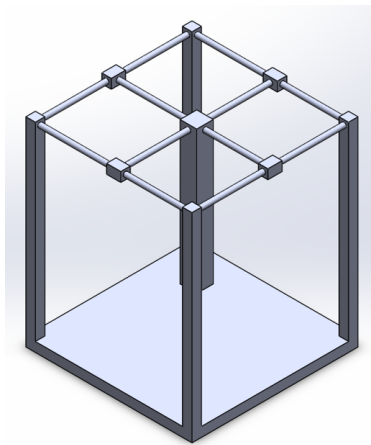

Figure 1; Preliminary SolidWorks Design for the D-MILE system

2.2.1 Goals

Core Goals:

C1.0: D-MILE is safe to use and operate in a consumer environment.

C2.0: D-MILE has a high ease of use.

C3.0: D-MILE is economical.

C4.0: D-MILE has a high level of optical precision.

C5.0: D-MILE has a high level of motor control precision.

C6.0: D-MILE is not burdensome to setup and power.

Advanced Goals:

A1.0: D-MILE is capable of multi-media printing.

A2.0: D-MILE has multiple optical subsystems expanding functionality.

A3.0: D-MILE is capable of printing gradients onto more resilient media such as wood.

A4.0: D-MILE has an improved level of motor control precision.

A5.0: D-MILE has manual control over the z direction.

A6.0: D-MILE will have an improved level of precision.

Stretch Goals:

S1.0: D-MILE has an industry standard level of motor control.

S2.0: D-MILE has fully automated adaptability in x, y, and z.

S3.0: Switching between media or the thickness of media without manual adjustment needed.

2.2.2 Objectives

(C1.0) To achieve our primary objective of ensuring the D-MILE is safe for consumer use, we will take steps to minimize risks such as isolating the beam path of our laser and strictly adhering to rules and regulations pertaining to the operation of a laser as dictated by their class. To expand this concept, several subsystem options are expanded on in the paper.

(C2.0) To ensure the D-MILE is easy to use, we want to have the firmware used by the printer interact with user-friendly software that accepts common files that are readily available by most users, and to have a convenient means to transmit files to the D-MILE for printing.

(C3.0) Given that the project is entirely self-funded, the cost to produce the D-MILE needs to stay within budget without compromising any core goals.

(C4.0/A6.0) Our laser will have an optical system to support its function and create a specific spot size at a predetermined and convenient location.

(C5.0) Our system will have a series of motors to give access to moving the laser focus freely in x and y. (A5.0/S2.0) Resources allowing, this objective will expand into the z direction with or without constraint. (A4.0/S1.0) As well, we would like to increase the level of ambition regarding the DPI of our system.

(A1.0) As the current focus of the project is a single media of our choosing, we would like to expand this to more than just one. This does not mean users can print or engrave on anything, as such a behavior would compromise consumer safety should the user not have the requisite understanding of the effects a laser can have on different media.

(A2.0) Written broadly, we will outline multiple optical subsystems to operate in tandem with the laser system, and would like to be able to include more than one of these subsystems, resources allowing.

(A3.0) Gradients could be produced by a Gaussian beam if we are able to quickly modulate the power delivered to the laser diode, or by controlling the beam path in time as well as x and y.

(S3.0) As materials change, it would be nice to be able to auto-adjust the material into the focus of the beam to ensure the precision of the laser is not affected. This process could even be adjusted and intertwined with the motor control to allow real-time changes of the z direction during printing.

2.3 Requirements Specifications

ID	Core Objective Requirements
C1.0	D-MILE complies with any and all laser safety requirements outlined in

	Section 4.2
C3.0	Project will not exceed \$1000.00
C4.0	Laser spot size will be at most 0.25" in diameter
C5.0	Motor control of 50-100 DPI
C6.0	System will not exceed 4'x4'x4' in size, weigh less than 100lbs, and use a standard USA Type A power cord.
ID	Advanced Objective Requirements
A1.0	D-MILE can print on both A4 Paper and non-composite/treated Wood
A2.0	More than one optical subsystem expanded upon in Section 3.5 in effect
A3.0	Gradients available beyond simple contrast between unburnt and burnt.
A4.0	Motor control of 150-200 DPI
A5.0	Either the laser or the platform will be capable of moving ± 5 mm in the z-direction.
A6.0	Laser spot size will be at or under $\frac{1}{8}$ " in diameter
ID	Stretch Objective Requirements
S1.0	Motor control of 300+ DPI
S2.0	Motor control extends to the z-direction, allowing for variability in z to be factored into print maps.
S3.0	The Platform/Laser will auto-focus onto the material surface.

Table 1; Requirements

2.4 House of Quality Analysis

The house of quality analysis lets us compare the engineering requirements with the customer requirements. This helps you to visualize how some aspects of the engineering requirements will affect the customer requirements in a positive or negative manner. It can be seen that within our house of quality analysis that there are some components that benefit both. One of the main ones being cost for engineering and affordability as a customer requirement. Looking at the figure it can also be seen how the engineering requirements will affect each other. One of the main ones being that the

cheaper the build tends to equate to a worse product quality. You must find a good balance between all of these requirements to create a good quality product.

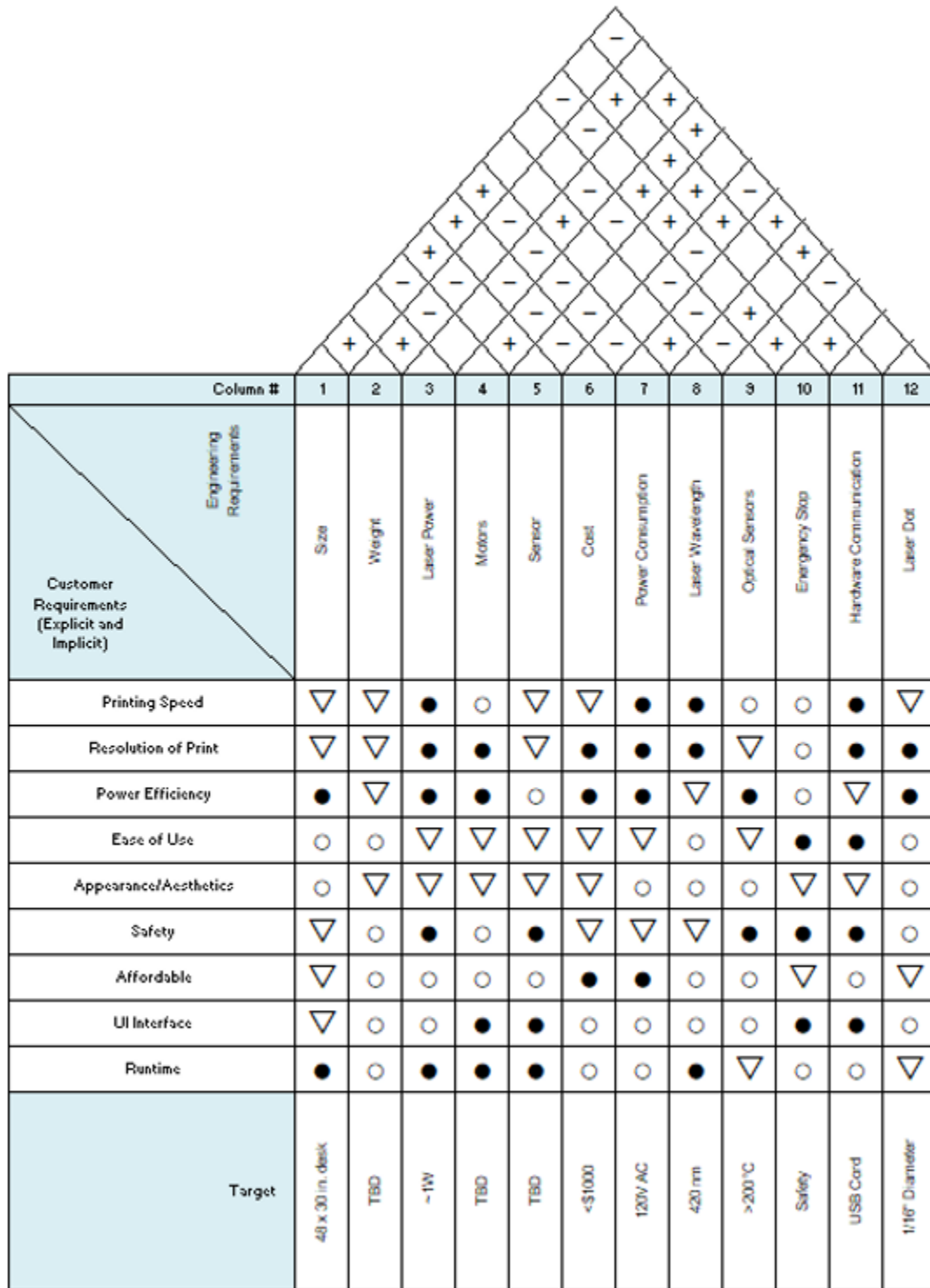

Figure 2; House of Quality

For our house of quality, we outline a series of key requirements for our project, being the printing speed which is dependent on our motor control. This means that as we increase the resolution from the core requirement of ~100 DPI, we increase the stress we're placing upon the print speed of our work. As the detailwork of our printer increases, we also increase the amount of time for a print job to complete, even if the level of detail on the image does not require a finer DPI. This serves as a good example for our philosophy when it came to the metrics we'd design our project around, we would value utility and performance over something like time to print. Ultimately, we feel that a better result done slower is better than a system more limited in the scope of what it can handle. Various subsystems are proposed and designed around expanding that very scope later.

Print resolution is based upon the beam parameters. We want our beam spot to be as small as possible, until we reach the point where the beam radius is limited only by diffraction caused by our chosen wavelength, not the system itself. However, such a small resolution would put a lot of stress on our DPI requirements, and so we're looking for a system we can "pull back" on the focus plane to expand the spot size to something larger but not dramatically affected by aberration. This allows us variable spot size based on the location of our image plane to not enforce a rigid DPI requirement.

Power efficiency is not tied to a requirement beyond how we get the power, but for a consumer project, the power consumption is limited in other ways. The power consumption of our laser, as well as the power requirements of the motors, UI, and other features will all contribute to the total power requirement of the system, and we want to keep that in mind when using the system as it doesn't do us any good to create a system that can perform printing without ink or toner if the electricity bill resultant from its use eclipses the cost of ink or toner.

Ease of Use is something our project wants to have, and we measure it primarily in terms of the setup of the device, but it is also affected and measured in more factors than we consider here, as everyone has a different level of ease of use.

Aesthetically, we'd like to avoid making the printer hideous, and want to make it seem in place, just as a regular printer or a 3D printer might in a normal environment. However, this can, at times, come into conflict with safety concerns, as the beam should not be exposed to viewing, which demands that some level of containment is built for the printer, and other factors limit our material choices.

Safety is paramount in everything we do, and our goal is to avoid anything and everything which would compromise the safety of those using the device. Our use of a laser comes with it a series of health risks and government issued requirements to meet and adapt to. As well as this, our use of a laser in conjunction with potentially flammable materials also comes at risk, and we cannot avoid dealing with this in some ways.

Affordability is a metric that we can consider as if we were to propose this project as a product on the marketplace, and try to improve our results while remembering that the cost to produce a feature might not be justified by the price increase in cost. However, for affordability the main concern is on our ends as we are self-funding the project. We all have budgets and different financial situations, and so we want to remain fair and equitable in terms of how much each group member has to pitch in, while also not forcing people to spend more than they're willing.

The UI interface has a series of things which affect it, but is generally less important than many others, as is runtime.

2.5 Block Diagram

The block diagram shows the arrangement of the various subsystems that need to be implemented in the project to build a working system. Interconnections between two blocks shows that one subsystem directly affects another, whether this is through input/output, power, or mechanical influence. For example, the connection between 'Data Storage' and 'Control signal generation' shows that the data stored in the system will be used to generate various control signals. The connection between 'Laser head' and 'Lens adjustment system' shows that the laser will shine a laser beam through the lens within the adjustment system.

The diagram can also serve as a check-list and a means to assign responsibilities between group members. As you can see in figure 3 below, subsystems have been grouped together into related groups. The different subsystem groups were then assigned to each group member depending on their major. These responsibilities do not mean that we are not allowed to work together on the system as a whole, but when we divide up to work alone on our respective areas we will be focusing on the subsystems in the block diagram that we have been assigned to.

Blocks in the diagram also have a current status assigned to them. This shows where we are currently at for the respective subsystem. If the approach to solve that block is still being investigated, we show that the block is under research (R). Because some subsystems might be bought rather than designed, we can show that the block has been acquired (A), or still needs to be acquired (TBA). If the block is going to be designed and built, we can show where in the design process it is with design (D), prototype (P), or complete (C).

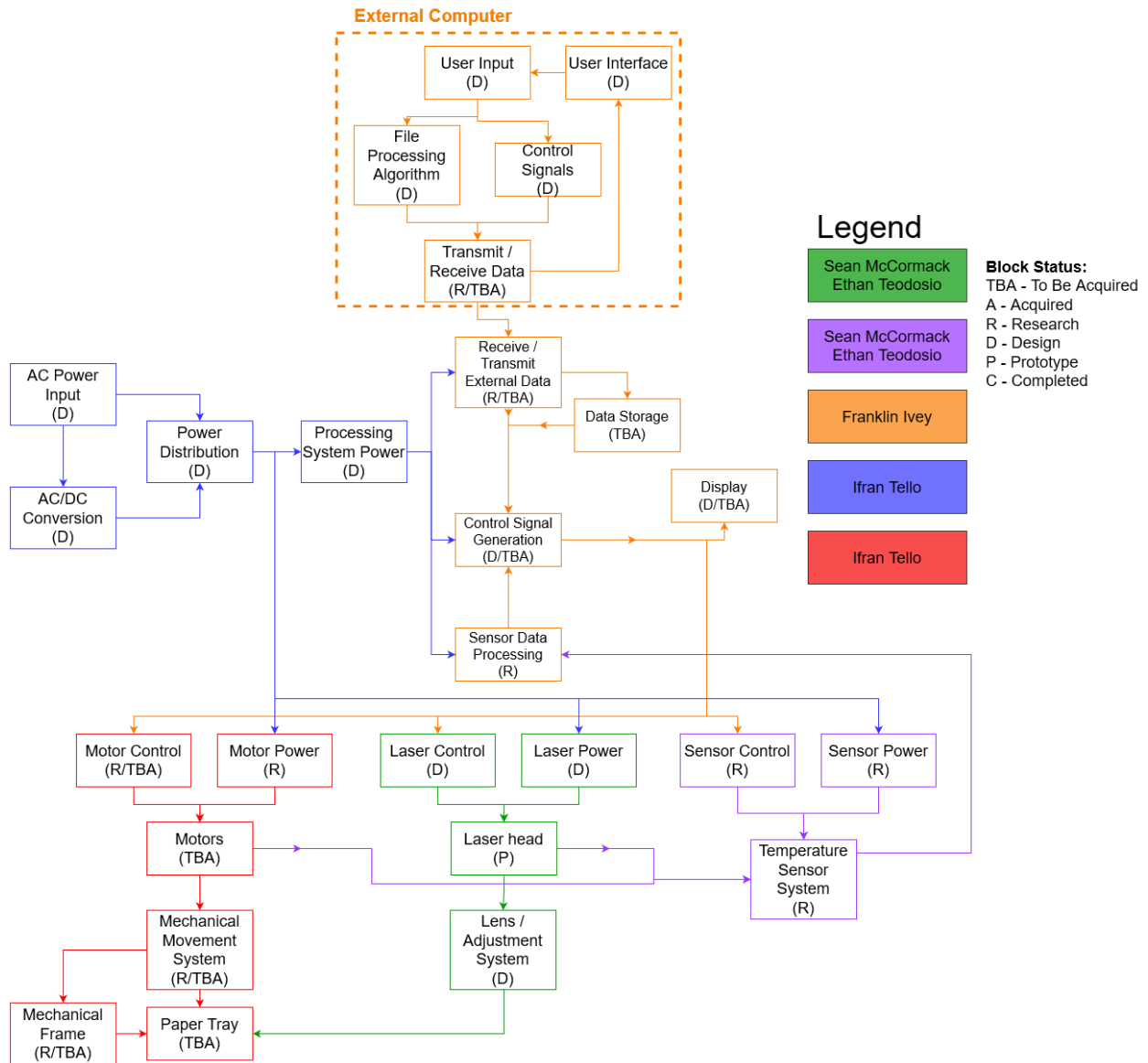

Figure 3; Subsystem block diagram and distribution of work

In blue, the power system will be responsible for converting AC wall power to the needed DC levels and distributing them throughout the board. This will mostly consist of determining how each subsystem within the engraver needs its power delivered, when, and to what specifications.

In red, the mechanical movement system will consist of the motors and pulleys that move the laser head around for engraving. This will happen much like a 3D printer or a CNC machine. The motor blocks are essential regardless of the design, but the mechanical movement system is more flexible. Designing how the frame is connected together, how the motors interact with the frame, and how the laser connects to the moving section of the frame are all questions that need to be researched for the mechanical movement system block

The computational system in orange consists of two main sections, the external computer and the microcontroller. These two sections are not shown as blocks, but the tasks that each need to complete are. For the microcontroller, it must receive data from the external computer and use it to generate control signals for the other subsystems. It must also process incoming data from sensors, and use this in signal generation. For the external computer, it must accept user input and process files, sending the data to the microcontroller. Once all of the blocks have been thoroughly researched, it will be a question of integration to code and build a working prototype.

In green, the laser system is essentially responsible for shooting a laser beam at the paper. While this sounds simple, specific calibration is required. The laser power block and the laser control block are responsible for providing the laser head with the specific parameters needed to generate a laser beam that will not burn through a piece of paper. Research into the laser head block will be finding a laser that fits all requirements and is within budget. The lens / adjustment system block will be the lens that focuses the laser, allowing it to have a small spot size and effectively engrave the paper without dissipating too much energy.

The sensor system in purple will just gather data and report it back to the microcontroller. Most research here will be deciding what sensors are necessary and align with the goals and objectives of this project.

3. Project Research

3.1 Existing Similar Projects and Products

The existence of printers and engravers is not a new invention, with the first iteration of one typically credited to Xerox with their laser printer technology made in the 1970s. This section will cover the several already existing products and even similar Senior Design projects that have tackled the idea of a laser-powered printer.

3.1.1 Xerox 9700

Largely considered the very first form of a laser printer that was designed, produced, and sold in the 1970s. It had a resolution of 300 dots per inch and could print 2 pages in one second. Our project ideally won't likely be as fast, but we want our resolution to be on par with the Xerox 9700. The processor of the Xerox 9700 printed by converting images and text into a grid of pixels in a process called rasterization, which converts lines and vector graphics into a grid of more discrete pixels. Doing so allows for a more consistent resolution image when printing, which can be very useful especially when creating several copies of the same image.

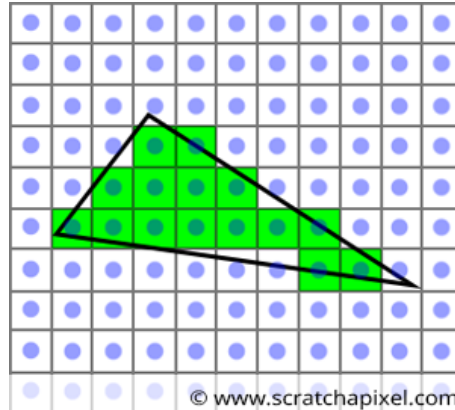

Figure 4; Rasterization example from ScratchAPixel

The above image is a simplified picture representation of the rasterization process, with the lines of the triangle being the original vector image, and the pixels in green converting that image into a pixel grid to best represent the original vectors. As this is the most consistent and widely known solution, this is most likely similar to what our device will do when converting images and/or text to engrave onto paper.

The Xerox 9700, as well as the vast majority of laser printers that have come out since its creation, uses a toner on the printing paper, or a special type of paper with toner already on it. Our goal is to attempt to remove the need for any toner and be able to print on a standard A4 printer paper

3.1.2 Computer Numerical Control Machines (CNC Machines)

Computer numerical control machines, most often called CNC machines, are automated systems that use machining tools such as drill, grinders, lathes, and more. These machines work by mounting the main tool, be it a drill or in our case, a laser diode, on a device that is able to move it on several axes. Many advanced drilling CNC machines are able to move in multiple axes in all 3 dimensions, or even move the platform the the material that is being drilled rests on. The most likely choice for our project is a very simple 2-axis movement CNC machine. The main tool is our laser diode, which will be faced towards the paper being printed on, and it will move on a plane parallel to the ground, since there is not much need to have depth in our movement like an advanced drilling CNC machine would.

Even with this approach, we are left with three options. We could have the diode be the main tool in motion, being able to cover all parts of the paper by using motors and rails to move the diode a full 2-dimensional range, the advantage being it will be a smaller device. Another option is to instead move the paper itself and keep the diode stationary. This could lead to better consistency in resolution or burn due to not needing the diode to move at all, but we also have the disadvantage need a very large platform for the paper itself to be able to move all around such that the diode can cover all points on the page. Lastly, we could combine the two into a system that moves the diode in only one axis, and the paper itself on the orthogonal axis. I find this very similar to a Cricut cutting machine, a consumer product that uses a knife on a rail and rollers to move the paper being cut perpendicular to the knife.

A CNC device that uses movements similar to the Cricut allows us to have the simplicity of moving the laser diode on only one axis, and with the rollers moving the paper we can keep the size of the device smaller than if we had a massive moving platform.

3.1.3 Laser Powered Wood Engravers

There are several consumer devices that use CNC laser machines to engrave onto wood panels, typically for cosmetic purposes. While there are CNC machines designed to cut into wood, or even metal in some cases, a wood engraver meant to print images onto wood is most similar to our project hence why it is being discussed here. A laser wood engraver is everything we want our project to become, that meaning our main printing source is just the laser diode and the medium on which we print has no need for additives such as toner or ink. Of course, instead of wood panels we will be shooting for printing on a standard A4 copy paper, but theoretically there is no reason we cannot design this device to do both.

3.1.4 Laser Inkless Printer (2021 Senior Design Project)

During the Spring 2021 - Summer 2021 Senior Design semesters, one group had a project with a goal nearly identical to ours, that being the creation of a printer using lasers and without the need of ink or toner. During the idea selection process, this specific project stood out to us as something we can try to improve upon. There is no denying this Senior Design project is a major inspiration to our project, and their research has helped our group with our own research. It would be a disservice to not mention this project when discussing existing products that are aiding in our research for our project.

The end result of this Laser Inkless Printer was indeed able to print readable text, but not in the way we are trying to achieve. They were able to print text by individually burning dots onto paper with each character taking up approximately a 4x5 grid with said dots. This resolution of dots is perfectly able to capture most important ASCII symbols, which is what they achieved. However, this is far below our stretch goal of 300 dots per inch. We are aiming to reach this stretch goal given the resolution that our system has at this time. Our goal is to not only print text, but any uploaded images as well. The below image is an example of what we hope to achieve with our laser printer:



Figure 5; Resolution output we are hoping to achieve[20]

We hope to achieve and even, if possible, surpass the level of resolution this former project reached, and their research and final product will continue to aid us in our efforts to create our own laser printer. More information on this project can be seen on the website of the group who created it:

<https://www.ece.ucf.edu/seniordesign/sp2021su2021/g02/>

3.1.5 Laser Etching

Laser Etching printers, which function in a similar range of function to the D-MILE design do exist within the market, but suffer from a series of drawbacks or constraints that serve as impediments to form or function. Notable examples that are readily available on the web are examples of hybrid engravers and cutters such as the LS Series by Boss Laser, or the FOBA Laser Engraving Machines. These suffer from a series of issues: primarily being the choice of etching medium. In all the marketing for these devices, they focus on acrylics, metals, or wood. They're designed as an etching solution that functions closer to a CNC machine or a mill, and do not operate in the same realm as a standard ink-printer would. Nothing about them shows the capacity to etch or cut into paper safely, or at least is not something they market. In addition, these machines are large, acting as standalone workstations or crossing into work areas of 14"+ wide but on 4 foot tables. None of these match the system specifications we're looking for in terms of compact design. What's more notable is the price tag on these options. Boss Lasers, for their entry level CO2 laser cutter costs on the order of \$5,000 per unit. The FOBA Laser Engraver does not even list a price per unit, and requires an outreach form to be filled out to inquire about such details. These, however, are marketed towards industry, rather than a consumer audience. In terms of consumer technology, a laser etcher will cost several hundred dollars, and are incredibly small or

narrow, and mainly used for ornamental work on wood. As it stands, there is very little operating within the space of a laser etching alternative to printing on paper, as almost all the market is focused on engraving or cutting onto larger scale devices as a form of machining in industry.

3.6.2 Laser (Toner) Printers

Commercial laser printers are very common, examples being the HP LaserJet series. These are printers which use lasers in addition to toner to print onto paper. Instead of ink, these printers rely on toner, a form of dry powder solution, which is used within laser deposition to produce similar results as ink staining paper. These printers are marketed in a similar way to our product's goal of being consumer, house-hold appliances. They're small and convenient to place, as well as running normally, and in practice feel indistinguishable from a traditional ink printer. Where these printers struggle, we feel, is in the purpose. Many articles can be found written to discuss the differences between laser or toner printers and traditional ink printers, but both fall short in requiring an additional consumable to function, be it ink or toner. These are necessary for the printer to be able to print, and can and will run out. This requires you to either risk running out at an inopportune moment, or buy in bulk and potentially not use the ink and have wasted money. In addition, there are health risks associated with toner which has been shown through studies conducted by the University of Rostock and Harvard which claim that toner can be seen as carcinogenic, and can be linked to lung disease and poses a health risk if inhaled. Overall, though, these printers are a viable alternative to ink printers, but still do not address the need for an inkless solution, but just create the need for a tonerless solution. Also of note is that modern printer software can lock out toner of other brands, forcing you to buy toner only from the printer maker, rather than whatever the best market option could be.

3.2 Document Processing

To engrave an image onto a piece of paper, the image must be stored in a data format that can be easily converted into instructions for the engraving system by the on-board MCU. To increase ease of use, this process of image conversion (or document conversion) must be as streamlined as possible within a user interface. Because printing and engraving is not a new technology, this problem has already been solved for standard printers, 3D printers, and CNC routing machines. While it may be possible to use pre-existing software from different printing or engraving systems to tackle the problem of document conversion, it may not necessarily be the best solution. Depending on the viability of existing software, we are faced with the following decisions on which solution to use for document conversion:

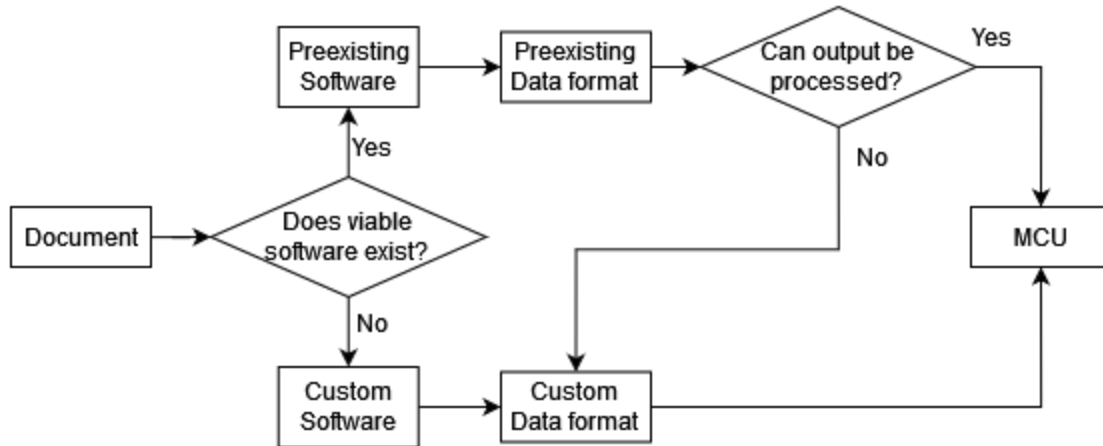

Figure 6; Decision diagram for software development

In the following sections, we will explore pre-existing software solutions for processing documents into data formats that can be used by a printing or engraving system. Then we will propose a custom solution and output data format, comparing to pre existing solutions to explore the viability of creating a custom software solution for the system.

3.2.1 Pre Existing Software

3.2.1.1 LaserGRBL

LaserGRBL is an open source GUI program made to interface with and control laser engravers that follow the GRBL standard. The program can import rasterized image formats and convert them into tool paths written as GCodes. When importing images, the program offers multiple customization options, such as vectorization algorithms, line-by-line GCode generation (and the ability to select horizontal, vertical, or diagonal lines), and options to control laser settings.

The program can save the toolpath as a text file containing GCodes, or it can interface directly with a laser engraver that is running GRBL firmware. GRBL is an open source, high performance GCode parser and CNC controller that is written to run on the Arduino Microcontroller platform, or more specifically the Atmega MCU family. If interfacing with GRBL firmware, LaserGRBL can monitor and control the engraving process via serial ports. The program has customizable GUI buttons, and can decode error codes sent from the MCU.

Even without the GRBL firmware, a raw list of GCode files can be useful for this project. GCode is a widely used CNC machine programming language consisting of a series of codes to tell machines where and how to move their tool heads. Each code is a letter followed by a series of numbers. Each letter indicates the type of instruction, and the numbers following are the parameters for said instruction. Some codes tell the machine where to move, while others define program or machine parameters. For

example the GCode 'X0' tells the machine to move its toolhead to the zero position on the X axis, and the GCode 'F100' tells the machine to use a feed rate of 100.

One benefit of using GCodes is that the CNC machine is not responsible for parsing complicated 3D models. By programming the machine with just movement instructions, program size can be greatly reduced. It also allows the user to manually edit tool paths, which can help troubleshoot the process of part creation.

For this application, the use of GCodes might have negative impacts on document legibility. When recreating a vectorized image GCodes can be very accurate as they are able to define exactly where and how the toolhead needs to move, allowing CNC machines to trace a line faithfully. When attempting to engrave fine text however, the vector-based method of toolhead movement might not produce legible print. Fonts in documents are rarely stored with vector graphics, so the only way to faithfully recreate a rasterized document with GCodes is to move the laser head in a series of horizontal lines across pixels. When attempting to load images with text into LaserGRBL, the preview of the toolpath using this method does not produce legible text.

3.2.1.2 RasterCarve

RasterCarve is a simple python script written by Franklin Wei on github. The script accepts any image format supported by the Open-CV library and generates a series of toolpaths encoded as GCodes that will engrave the image with a CNC machine. The Open-CV library is an open-source computer vision library that includes functions and data formats to read common image file formats, like png, jpeg, and bmp. Images are translated into a series of lines, where the tool depth, angle, and spacing can be customized to adjust image clarity. The script also includes options to adjust CNC machine parameters like tool feed rate, plunge rate, and angle. All of these parameters are communicated via GCodes, and are saved to a file that can be run on any CNC machine that supports the GCode programming Language.

The main advantage of RasterCarve is the fact that it uses a command line interface rather than a GUI. Because the desired result is to seamlessly go from document file to printable instructions, a CNC machine oriented GUI could add unwanted steps in the engraving processes. With RasterCarve it would be very easy to create a simple program that calls RasterCarve on a specified file with predefined settings that work, and sends the resulting GCodes to the D-MILE system. The disadvantage of this approach is that if the user wanted to edit settings about the encoding process, it would not be as easy as using a GUI.

3.2.1.3 ImageMagick

ImageMagick is a general purpose software suite for digital image creation and editing. The program does everything that an image editing suite would normally do, except it does so via a command line interface. ImageMagick also uses multithreaded computations when handling images. It was originally released in 1990, and has remained in development since. Because of this, several open source programs use ImageMagick as a backend image creation tool.

For this project, we could use ImageMagick to convert any image or PDF document into a bitmap image that can be read directly and printed by the MCU. This method would easily support many image types and would be virtually lossless, but would be costly for data storage due to a lack of compression.

3.2.2 Proposed Custom Software

The goal in writing custom software for document processing will primarily be producing a custom output format that is optimized for the microcontroller system. Assuming that storage capacity is not a constraint, the ideal format is an uncompressed bitmap simply containing which pixels (or dot locations) on the page need to be engraved with the laser. If altering the laser power to produce shades of gray is desired, the bit width per pixel can be changed to reflect the amount of shades. Then the microcontroller can cycle through each pixel, move the motors as desired, turn the laser on and off, and then continue to the next pixel. This format is very similar to a .bmp (bitmap) image file, except for the exclusion of complex header information. Because much of the information contained in a .bmp header will already be known for the system, it is useless information and will make reading the file more difficult. Some header information will need to be included, but will most likely only include the output dimensions in pixels and the desired real-world paper size.

The proposed software will take desired output dimensions (in inches or pixels, with user-definable DPI resolution within the system’s range) and a rasterized image file as inputs. Then, the software will parse the image file and map its pixels onto the output pixel space. This step can be monitored and customized via a GUI which will allow the user to move the image around, resize the image, and rotate the image on the output space. Once the output pixel space has been calculated it will be dumped as a bitmap into a text file, which will be sent to the D-MILE system for engraving.

Because image file formats are so standardized, file support can be implemented through open-source libraries such as Open-CV (see section 3.2.1.2). If support for non-rasterized images is desired (like PDF documents, or SVG images) a rasterization algorithm will have to be implemented. However, this can be an additional feature to implement only if desired.

3.2.3 Software Comparison

	LaserGRBL	RasterCarve	ImageMagick	Proposed Software
Input File Types	Jpg, png, bmp	Open-CV supported images	Over 200 image formats	Png file
Output File Types	GCode file	GCode file	Over 200 image formats	Custom bitmap with minimal header

License	GNU GPL 3.0	GNU GPL 2.0	Derived Apache 2.0 License	None
GUI	Yes	No	No	Yes
CLI	No	Yes	Yes	Yes

Table 2; Software comparison chart

After comparison, we will be choosing to develop our own custom software for this project. While it will take more development time to code the software than it will to simply adopt an existing solution, doing this will allow us to tailor the output type more directly to our system which will save in development time and complexity when working on the microcontroller firmware and design.

We have made this decision because none of the existing software produced an output data format that would be convenient for the microcontroller to interpret, or that would produce desirable results in the print process. Similarly, none of the software solutions examined provided an easy, seamless user interface that would fit the goals of this project.

3.3 Microcontroller System

Because the Microcontroller will be the central point of control for the entire D-MILE system, selection of the MCU is an important decision. However, selection of a microcontroller is not as simple as picking the cheapest option, or the fastest processor. To make this decision we must first define which specifications are most important, so that we can correctly interpret our findings while researching existing MCU options. The MCU system will be completing these essential tasks:

- Control required motors
- Read stored data to calculate motor movements / positions
- Control laser (either by turning laser on and off or by varying power)
- Process data from sensors
- Initiate safety features
- Interface with external computer to receive data and control signals

Based on these tasks, we can see that we are primarily looking for a microcontroller that has a multitude of GPIO pins, a good interrupt system, and support for reliable communication protocols. The Microcontroller must also run at a fast enough clock rate to accurately control motors, read stored data, and process sensor data all at the same time. While the engraving process can happen at relatively any speed, if the MCU is not also able to process sensor data at the same time then any safety features that are implemented will not be reliable.

Another important consideration is the software development environment that is associated with a microcontroller. Considering that there is limited time to develop and build the project, any efficiencies that can be found in software development or debugging will free up group members to work on other aspects of the project. Any

saved time on this front will also allow us to spend more time optimizing the system, and improving any features that might not be performing as desired.

3.3.1 ATmega family

The AVR microcontrollers made by Atmel (now acquired by Microchip Technology as of 2016), are one of the first microcontrollers to use flash memory on its chips at the time they were first made. The family of microcontrollers we specifically want to look at is the megaAVR family, also known as the ATmega series or family. This family of microcontrollers has a very large selection, with the ATmega328p being the most popular microcontroller by far. In table 3 below, we look at three different devices from the ATmega family.

Device Name	ATmega328p	ATmega2560	ATmega4809
Frequency (MHz)	16	20	20
Instruction size (bits)	8	8	8
Flash memory (kB)	32	256	48
RAM (kB)	2	8	6
GPIO pins (#)	23	86	41
Supported Protocols	UART, I2C, SPI	UART, I2C, SPI	UART, I2C, SPI,
Currently Owned?	No	No	No

Table 3; ATmega family device comparison

MegaAVR chips, especially the ATmega328, are one of the most widely known microcontrollers on the market. This is due to their relatively cheap price, low power requirements, and most importantly its ease of use. The Arduino is a development board that contains the ATmega328, and the Arduino is very popular amongst hobbyists and beginners in coding and embedded systems. Due to the popularity of the Arduino, and the very easy-to-use software needed to program it, the ATmega328 could be a reliable choice for a microcontroller. There are thousands of public software packages out on the internet specifically for use of the Arduino, which could help us with programming and cut down on time needed just to program the ATmega328. Similarly, the GRBL firmware that was discussed in section 3.2.1.1 was written specifically to be run on the ATmega microcontrollers within the Arduino platform.

3.3.2 MSP430 Family

The MSP430 Microcontroller family is a series of low-power 16-bit MCUs. They are known for having very low power consumption, and come with 6 different low power modes to disable different clocks and CPUs to save power. The MCU family boasts up to 512 kB of flash memory on certain models, and a large variety of internal modules to drive peripheral devices. Devices also include internal communication modules, which support popular protocols like UART, SPI, and I2C. We've decided to consider this family of microcontrollers because we have had experience working with several different devices through Embedded Systems labs.

Programs for MSP430 MCUs are written in C through an integrated development environment called Code Composer Studio. Code Composer Studio was developed by TI for their microcontrollers and processors to make the development and debugging processes for their devices as optimal as possible. The included compiler (also written by TI) is optimized to reduce code size and increase performance on the devices.

Certain MSP430 devices are optionally packaged with a development board, which includes on-board JTAG debugging, flash-memory programming, and pin headers for GPIO pins. Certain models include buttons, LEDs, and LCD displays. When used in conjunction with the Code Composer Studio IDE, the MCU can be debugged in real time by running code line-by-line, viewing variable states and locations, and pausing code execution. These features make developing code very smooth, and significantly speed up the debugging process.

In the table below, several devices of interest from the MSP430 family are listed and compared. Some devices are currently owned by one or more group members due to previous experience with the microcontrollers. To show this, we have added a row indicating if the device is owned.

Device Name	MSP430FR6989	MSP430G2553	MSP430F56
			32
Frequency (MHz)	16	16	20
Instruction size (bits)	16	16	16
Flash Memory (kB)	128	16	256
RAM (kB)	2	0.5	16
GPIO Pins (#)	83	24	74
Supported Communication Protocols	UART, SPI, I2C	UART, SPI, I2C	UART, I2C, USB 2.0
Currently owned?	Yes	Yes	No

Table 4; MSP430 device comparison

3.3.3 STM32 Family

The STM32 Microcontroller family, made by STMicroelectronics, is a series of 32-bit microcontrollers that are all based around an ARM Cortex-M processor core. The ARM Cortex-M processors are developed specifically for microcontroller applications, and are optimized for low-power efficient computing. Because all STM32 MCUs are based around the same or similar cores with added internal memory and peripheral modules, the family has a wide range of applications.

Software development for the STM32 family occurs within the STM32CubeIDE, which is an IDE developed by STMicroelectronics based on the Eclipse IDE. Unlike Code Composer Studio by TI, STM32CubeIDE includes a device configuration tool where you can configure the microcontroller's different modules with a GUI. This greatly increases the ease of software development, compared to manually setting registers by searching the data sheet for register names and desired values.

In the table below, several noteworthy devices from the STM32 family are listed and compared:

Device Name	STM32G0B1VC	STM32F446RE	STM32F407VET6
Frequency (MHz)	Up to 64	Up to 180	Up to 168
Instruction size (bits)	32	32	32
Flash Memory (kB)	256	512	512
RAM (kB)	144	128	192
GPIO Pins	94	114	140
Supported Protocols	UART, SPI, I2C, HDMI, USB	UART, SPI, I2C, SAI, CAN, SDIO, USB 2.0	UART, SPI, I2C, CAN, SDIO, USB 2.0

Table 5; STM32 device comparison

3.3.4 Family Comparison Conclusion

After comparing the specifications of the different microcontroller families, we are going to begin development with the STM32 family of microcontrollers. This decision was made primarily because of their large flash memory size, which will support the potentially large size of the system's firmware. The second consideration that led us to this decision was the instruction size for each microcontroller family. Because we wish to read and write large amounts of data to an external storage device and to interface

through commands with an external computer, a large instruction size is desirable. This means that the microcontroller is going to be doing less work per instruction when moving data, or processing strings within the firmware. The 32-bit nature of the STM32 family ensures that our microcontroller will be able to handle these tasks while also accurately controlling the motors and laser.

As for devices, we have chosen to begin experimenting with the STM32f407VET6. Out of the devices considered, this microcontroller appears to be the best in terms of specifications. Also, we were able to find a development board sporting this microcontroller very easily, that includes an SD card slot and header pins for nearly every GPIO pin on the microcontroller. This will greatly speed up development, allowing for easy testing of firmware while it is being written.

3.3.5 External Data Storage

Because of the high print resolution that we are attempting to achieve, instructions for a given image are likely to be larger than microcontroller memory will allow. At a maximum of 300 DPI for an 8.3 in x 11.7 in piece of paper, there will be 8739900 pixels. If the image is black and white (where a 1 signifies a black pixel) and sent to the microcontroller as a pure uncompressed bitmap, the system will need at least 1.04 MB of storage just for the image that needs to be printed. The data format sent to the printer is likely to be more complex than this, so it is safe to assume that a peripheral storage device is going to be needed.

After doing preliminary research, SD cards appear to be the only viable storage solution for this project. Attempting to use a flash memory IC will require complex wiring, and attempting to use a USB flash drive will require the addition of a USB controller with complex coding structures. SD cards on the other hand can be interfaced with using serial communication and can be treated as a raw memory block.

3.3.5.1 SD cards

SD cards are an industry standard for multimedia storage. On each SD card is a small controller and a memory chip (commonly NAND flash). Depending on the generation of the SD card, the memory capacity ranges from 2 GB to 128 TB. As the SD specifications have been updated over time, the maximum capacity has continually increased. SD cards have traditionally supported SPI communication with the internal controller, which has made the storage format popular among embedded systems. While SD specifications versions 1.0 through 6.0 require cards to support the SPI protocol, the SD 7.0 specification warns that the SPI protocol is now optionally supported. Therefore, any SD card that is under 2 TB (the maximum size for the SD 6.0 specification) in memory can easily interface with microcontrollers, offering an easy and cheap storage solution.

The main trouble with interfacing with SD cards is that they exclusively operate on 3.3V logic, while most microcontrollers use 5V logic signals. Because of this, it is relatively rare to see an SD card directly connected to the pins of a microcontroller.

There are many SD card reader modules on the market that handle voltage conversion, primarily marketed towards the Arduino platform. It is not worth exploring the different SD cards available on the market, given that there are so many different options that are functionally similar. For this project, we will likely be choosing the cheapest SD card that can reliably hold the amount of data needed. This will most likely not be a name brand card.

3.4 Laser System

Within this section, we will discuss the laser system that is used and what led us to choosing the laser and optical parts that we ended up with. Discussion of the different types of techniques that will be used for engraving into paper. We will also talk about different paper types and materials and how they affect the printing and how we plan to account for these issues. Lastly, within this section we will also discuss the optical setup that we choose and the laser type, beam shape, power, and lenses that are chosen. We will also discuss how we plan to reach our resolution using the optical components.

3.4.1 Laser Type

Within this part we will discuss the different options we are considering and looking at. The previous group that did this project used a 1 W 405-450nm, laser diode and laser diode controller. Due to this we knew that we wanted to look at lasers that tend to be in the same spectral range and close to the wavelength of ultraviolet. We noticed that the previous group struggled to find a laser diode that worked. This was seen as they commented that they ended up buying a lot of different laser diodes until one worked with their laser diode controller. This was a very important piece of information that shaped what we are going to buy and how we plan to look at lasers and controllers so we do not experience the same issues that they did. The three main types of lasers that we ended up looking at are diode based lasers, gas lasers, and fiber lasers. Each of these laser types have very specific operating guidelines as well as perks to using them as well as downsides.

3.4.1.1 Gas Laser

Gas lasers are lasers that use a gas such as Helium Neon (HeNe) or Carbon Dioxide (CO₂), to create a continuous light laser. Gas lasers are also used in many different applications. HeNe lasers are very common in consumer and educational settings. This is due to the fact that they have low power but steady performance as well as they operate in the visible wavelength spectrum. CO₂ lasers are much more powerful, and tend to be used in applications within industry. CO₂ lasers tend to have a higher output wattage. These lasers are used in many different applications, one of the main ones being used in laser etching or cutting. These lasers are larger and tend to be more expensive than the other laser options. CO₂ lasers run at a high wattage, from

50W to 100k+W. These lasers also operate around 10um, which can't be seen by the eye. Due to this they pose a significant risk of damage and would pose a struggle to adapt to a consumer setting. Overall, these lasers are useful and would work great within our system, however gas lasers either lack the required power for etching, or operate in ranges far beyond what we need. When you factor in the cost of gas lasers are not the right laser for this application.

3.4.1.2 Fiber Laser

The next laser we looked into was fiber lasers. This is because we thought that fiber lasers would be a great solution to our problem. This is due to the fact that fiber lasers use an optical fiber that is doped to serve as the active gain medium for the laser to operate in. This means the laser light is both generated and delivered by a flexible and positionable fiber. This could also serve as a way to contain the beam from start to finish and would allow us to place the laser elsewhere on the system. When you implement an optical lens system at the end of the fiber you will be able to focus the light easily and only have to hold the lens and fiber at the printing point.

Fiber lasers can also just be a laser diode that is fused to the end of a fiber optic cable. Due to the laser diode being connected to a fiber cable directly you will be able to move the fiber output around on a printer with relative ease. This is because the laser would be set up on the side and just have the output fiber move around the system. Within industry, fiber lasers are used due to their high output power, these lasers are used for cutting and welding metals. One of the main issues we had with this is finding a fiber laser that operates within the spectral range we are planning to use is difficult and the fibers themselves tend to have large amount of loss across the fiber due to it not operating at the normal wavelength that fibers run (1550 nm). This was one of the big downsides we saw to using a fiber laser as we would need to pay close attention to the attenuation across the fiber.

3.4.1.3 Laser Diode

Laser diodes are a great option for a compact laser that can operate at a high or low power. Laser diodes are used all over the place and as long as you have a decent cooling setup these systems can run for extended periods of time. Laser diodes are made using a semiconductor similarly to how an LED is made. Due to this, laser diodes tend to be relatively cheap to produce and buy.

Throughout history laser diodes have been used in laser pointers, DVD readers, and laser printing. This made laser diodes a good option and something that we should look into for our system. The wavelengths that laser diodes cover tend to have a wavelength between Ultraviolet (UV) to infrared. This is very important as for our system we are wanting to find a laser that is within the range of 400 nm to 450 nm. This makes laser diodes a great option for our project. Another perk to using a laser diode is that they allow you to vary the output power. This is done by changing the input current into the diode. Once you reach the operating current it is very easy to change the output power by adjusting the current going into the diode. This feature made laser diodes an amazing option due to the fact that we are planning to allow the user to print onto

different types of materials. This would allow the user to easily change the current into the laser hence allowing you to print onto a different type of material.

3.4.1.4 Choosing the Laser Type

We chose not to go with a gas laser due to the fact that there were none at an affordable price that would work. This is mainly due to the fact that most affordable gas lasers tend to not have the output power we require. A CO₂ laser would work great in our project however finding one at a cheap price wasn't really a viable option. Also it should be noted that there are not any cheap gas lasers that operate between 400-450 nm. This means that gas lasers are not a feasible option for this project. This led us into looking at fiber optic lasers. We really liked the idea of using a fiber laser due the fact that we could use the movement stage to just move around a fiber and not have to mess with too many optics. However after looking into fiber lasers we came to a conclusion that they were going to end up costing more than we had initially planned to spend on a laser. This left us with our last option that was laser diodes. Given all of the benefits of laser diodes it made sense for us to explore this route and see what we could find in terms of a laser diode that operates between 400-450 nm and has a turn on current low enough that we will be able to vary the output power.

For our project, we found a 405nm laser diode that worked very well. As expected, it falls within the 400-500 nm range, but can lase at lower input currents. The maximum output power of this laser is 500mW. This gives us variability in power control, and as a 3B laser, is not as hazardous as the previous Class 4 laser risks are. This laser also has a PWM signal to allow power modulation which we were wanting to use for our system.

3.4.2 Beam Profile

We were considering many different types of laser output, but it can be narrowed down to two main types. These are the "top hat" beam, and the Gaussian beam. The description and benefits breakdown is as follows:

A top hat beam is so called because the spot size created by the laser has a flat top, and sheer drops of intensity past the peak. This results in a more binary output, either being a flat, stable value, or no output. This is useful for maintaining clean edges in engraving, as well as being efficient with ablation.

A gaussian beam is much easier to create, as it tends to be the standard output of commercial lasers. As well, due to the fact that energy that could engrave, albeit at a lower rate, exists on the fringes of the highest intensity spot, it can be used to bevel the edges of an engraving. This can be made

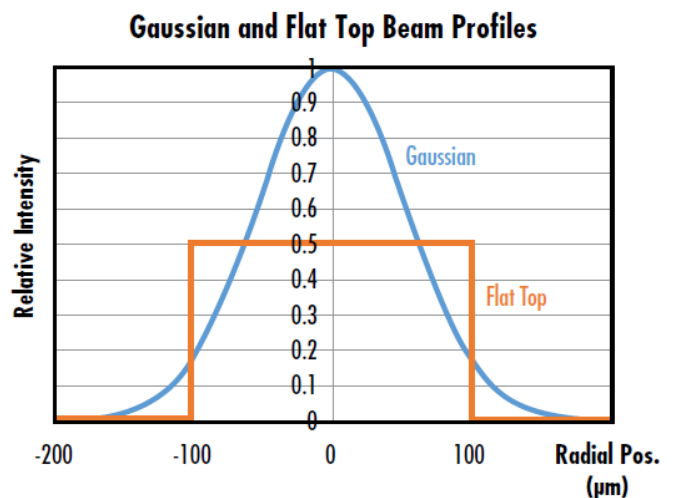

useful to prevent hard edges on engraving material such as paper, leading to less cutting potential.

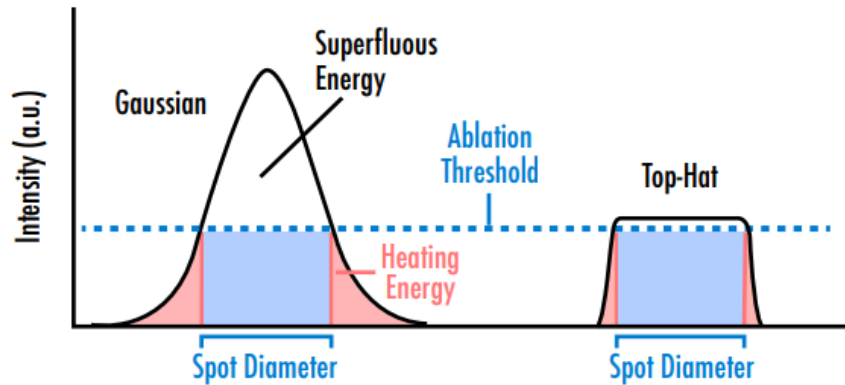

Figure 7-8; Gaussian, Flat Top, and Top-Hat beam profiles[1]

When it comes to which beam profile we should use, it is more efficient to rely upon a top-hat profile since there is less wasted energy upon reaching the minimum level for engraving or ablation. However, doing so would cause limitations in the options we have access to with engravement detail work, and the process of using an optical system to average and cap the power from a gaussian into a top hat would add overall cost and increase the optical path length.

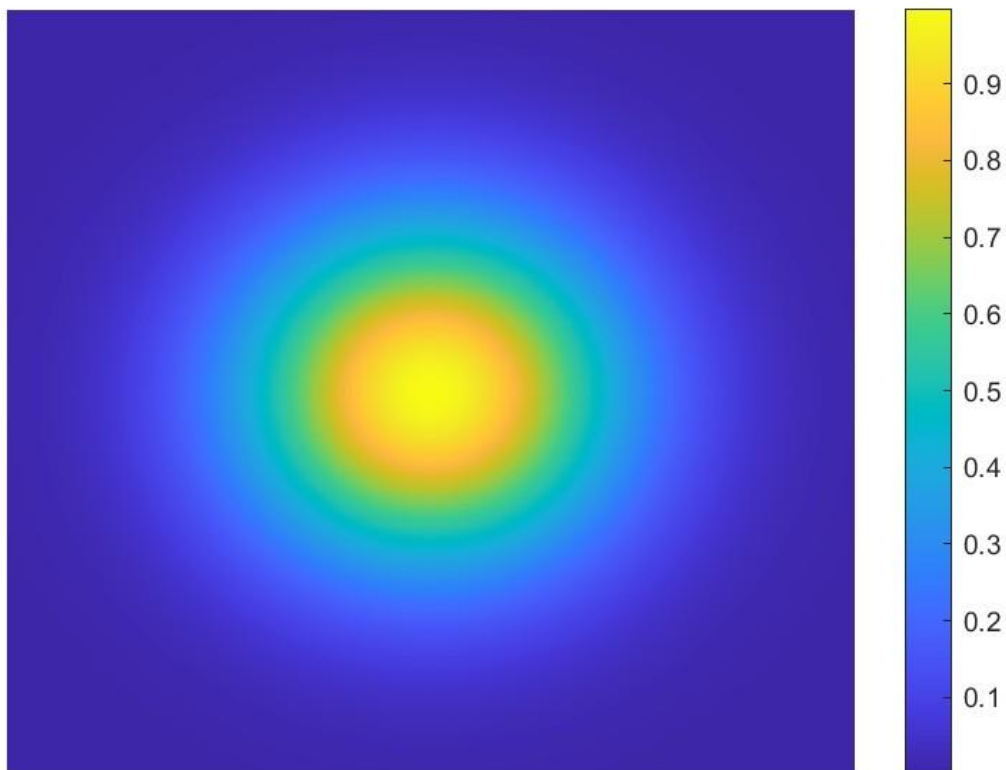

Figure 9; Intensity Graph of the Gaussian beam profile that will be used in our system

Overall, for our purposes, it makes the most sense at this point to operate with a standard gaussian beam profile, and reduce the peak power to cause the fringes of the gaussian to pose little issue with precision. This will also allow us more freedom when producing a gradient on materials like wood.

Ultimately, for the second laser diode we acquired, and the one being used at the time of writing, the laser emits a Gaussian beam. In order to get to a top-hat beam, we would have to build an optical system to average the peak optical power about the spot diameter. This would be more efficient in terms of burning, and result in a tighter focus without the lesser burning around the main focus spot. However, for our project an advanced goal is to pursue gradient effects onto wood. In order to achieve this with a top-hat beam, we would have to modulate the beam power in real time, or do multiple passes on the wood, which also has the drawback of “overburning” a location. That being said, if we stick with using a Gaussian, we find that this drawback is non-existent, as we can decrease the power and rely on the fringes to blend the burned effect into the wood, which can serve as a novel feature.

3.4.3 Laser Power

For the laser power we wanted to get a laser diode that had many options to vary the power. This would aid us in being able to vary the power greatly and etch/engrave on many different types of mediums. Given that this is one of our stretch goals is to be able to print onto different types of mediums. This would aid in a larger adoption of this printer if it were to become a commercially available printer. Due to this we looked into how powerful a laser with a wavelength around 400-450 nm would need to be to be able to engrave into different types of materials.

We learned from the previous senior design group that they used a 1W laser at 405-450 nm. Due to this we figured we probably need something around this power to be able to engrave onto both paper and other materials. As we did more research we realized that since we were going to be operating at 405 nm that we would probably be able to get away with less than a 1W laser. This led us into looking at a 500 mW laser as they are not super expensive but will hopefully perform the tasks required while also giving us more control over the output power and allowing the options for printing onto many different types of materials.

3.4.4 Optical Setup

For our optical setup, we have many different options. This section will comprise of all the options that were considered as we looked at many different options for mounting the laser. If we decide to mount the laser off of the x-y stage, our system will be composed of mirrors as the mounting option for the laser will demand it.

Next we need to be able to focus the beam. This will be done with a series of lenses meant to collimate the beam along an optical axis that is determined by the mounting method used for the laser. Then a series of lenses to focus the beam onto a spot size we can control to define the D-MILE’s resolution. For our system, we have a series of factors to balance within the lens design:

Cost
Size
Optical Path Length
Resolution / Spot Size
Aberration

For the sake of our system, we can include a series of irises in an attempt to limit off-axis rays as well as any back reflections that may occur due to the lenses. Then focusing only on on-axis rays to a collimated spot size. We ensure that our aberrations are limited to defocus, magnification error, and spherical aberrations. By designing with a defocus term, we can correct both first order aberrations, and work to minimize spherical aberration. This however should not be the primary issue of lens design.

One main issue is the lens focal distance, as our preliminary lens design had the optical track length at 1.7 meters due to the lenses having 850mm focal lengths. For the final project, to ensure the D-MILE meets the design restrictions established for weight and size, the optical path length has to be reduced, which in turn puts more strain on the lens design.

For the lens design itself, we have to focus on limiting cost and size as well, to ensure the feasibility of manufacturing or procuring the parts designed, which in turn applies more stress to the design process.

3.4.5 Optical Workspace Detection Method

Another option for something that may be worth looking at would be the addition of a second laser into the system. This would allow the user to turn on a less powerful laser, such as a red or green laser that could be turned on instead of the violet laser. Turning on this laser it would be used when the user is setting up a print it would show the user where the print would take place on the material. This would allow the user to move the material so that they do not go off of the printing surface they are using or print onto spots that they plan to keep. Adding this function would add to the quality of life of the system as the user would have more control and be able to see the print area before spending the time and money on the materials that are used on the print.

However we are also considering the idea of just running our violet laser at a low significantly lower power so it would only be visible and not actually engraving. However, while this would not be difficult to do, a big concern would be that the user would have no way to tell if the laser is operating at engraving power levels or not. Due to this we are planning to add another laser into the system that operates closer to the output level of a laser pointer. Laser pointers output power is around 5mW and would be classified as either a class 2 or class 3R laser. These lasers are low power which make them ideal for this application.

3.4.6 Recap of Laser System

To recap the laser system that we plan to design, the system will have a 405 nm laser diode that has a maximum output of 500 mW. This laser will be used as the main laser within the system and will be able to engrave onto paper as well as other materials

that we choose to experiment with. The beam shape of this laser beam will be a Gaussian shape as attempting to make a flat top beam shape using optics was deemed to be too expensive, we wanted to focus on other optical components of the system. Next we have decided that we will go with mounting the laser onto the x-y movement stage as this will allow for better control while also limiting the optical path length that the beam will have to travel. We partly chose this due to the fact that we want to cover our beam to the best of our ability due to how powerful the laser diode is.

Next, look at the system that would be able to tell the user where within the material the system plans to print. For this we are looking at getting a low power laser pointer that operates between 500 nm-700 nm. We are planning to go closer in between the colors of red and green as this would benefit someone who has red-green color blindness. However, as budgetary and time restrictions exist we may end up with a cheaper laser that can ship faster that operates within the range that someone with color blindness may not be able to see.

3.5 Fire detection System

Within this section we will discuss a fire detection system that will be a fail safe if something were to happen and the microcontroller were to fail or too much power were to be sent to the laser. This will help in making sure our product is easy to use while also being safe. For our figure detection system, we want to integrate optics into our safety processes. To do this, we have multiple options. Some of the options we have are infrared imaging, spectroscopy, and a bandstop filter sensor. We also can look into how an optical fire alarm works.

3.5.1 Infrared Imaging

To ensure that fires are not started, we could use an infrared camera system to image the work area, and should the temperature of the work area begin increasing beyond safe levels, could trigger an emergency stop or pause in the execution of the engraving process to prevent a fire from starting. For these options we are going to opt to not use infrared imaging due to the fact that infrared imaging systems tend to be expensive. This has made this option not plausible given that this project is not sponsored.

Infrared imaging, however, is still the most optimal and easy to use setup for detecting fires as is their purpose to detect and image heat onto a sensor. These could be mounted further away from the platform and image the whole of it, rather than go spot by spot, which gives a large margin for error in detection. However, due to the cost of these elements, and the lack of any form of optical design requirement, we plan on looking elsewhere. Even small infrared imaging cameras for consumer use range from several hundred dollars to tens of thousands. Getting a stationary thermal sensor is also not as simple as ordering one, and may require getting quotes or appealing to a seller with interest before a price could be disclosed.

One way to make use of infrared imaging without breaking the bank or expanding the scope of the subsystem beyond its relevance would be to serve as a go-no-gauge

for the system. If the infrared system saw heat in the work area prior to turning on, it would be indicative of a hand or something else obstructing the work area, and would not allow the system to begin lasing.

3.5.2 Spectroscopy

Alternatively, we can opt to not use infrared imaging, and instead focus on identifying when a fire starts, and snuff the fire out using an optical detection system. This, too, could use infrared, or could rely on spectroscopy to perform a similar function to analyze when light is being outputted by the sample. Spectroscopy is most used for analyzing the scattered or reflected light by a sample or other object for analysis, and such could be used for our project, but isn't a perfect fit, especially given how particular spectroscopy is about coupling light. In our setup, we do not have the luxury of being able to couple light from a fire that could start at any given location into a fiber which can then go into a spectrometer. Since spectroscopy suffers from a high cost just as infrared optics does, we instead have a third option. The spectrometers used in laboratories even at UCF each run upwards of \$2,000 per unit, and so this entirely nullifies any potential advantages the spectrometer might bring.

3.5.3 Bandstop Filter Sensors

Due to the nature of a laser, an enclosure will have to be constructed around the laser printer for safety reasons, but this has the added benefit for ensuring that the background of our optical system is dark. Then, by using a sensor with a blockout filter for the operating wavelength, we can use this detector to measure the levels of light within the enclosure. When light is produced by a fire, this will be detected and can be used to trigger an emergency stop of the laser, and we can integrate a CO₂ system into our printer to act as a safe method for starving fires of oxygen without causing a mess or a hazard to the process.

At this moment, the system would be an enclosure to ensure dark field imaging can be performed. We then use a detector with a line filter for blue light to image the work table. When the detector picks up an optical signal above the noise threshold, it will send a signal to the emergency shut off for the laser system to turn it off, as well as trigger the release on a CO₂ system we can design.

The Band-Stop Filter would attenuate the lower wavelengths to low levels, while remaining unaffected for all other wavelengths. We then apply this filter to a CMOS camera pointed at the beam spot. We then have this CMOS sensor and associated software automatically check the current light spectrum it sees against established thresholds for noise, and if the light detected in the visible range exceeds the threshold, can be used as a trigger for an emergency stop and fire prevention system such as CO₂ gas. Due to the cost to set up a band-stop filter, we could always combine a high-pass and a low-pass, or just use a bandpass filter for wavelengths in the 600-700 nm range where fire would produce the strongest light output.

However, one issue this system would have, just like the others, is cost, as well as only being useful if the safety of the system is compromised. In addition, releasing

concentrated CO2 into an area could set off home smoke alarms, or lead to potential issues in the event of a leak or excessive use.

3.5.4 Optical Fire Alarm

Similar to how some conventional fire alarms work, we could integrate a laser “tripwire” into our system that would automatically go off and trigger an alarm to sound letting the user know that smoke has been detected within the printer space. Fairly simple, but the sensitivity could be increased based on tinkering with the optical receiver/photodetector part of the tripwire. This would increase the safety precautions of our system, and help build confidence in the system without having to monitor the work area as closely.

This system already exists, it makes use of an infrared LED that is on and a photodiode that is into an open area. The photodiode isn’t able to see the infrared LED by default as there is a block between the two, however they are both pointed into an open area. This can be seen in the figure below. Now when smoke is inside of the chamber the infrared light is scattered off of the particles of smoke, this triggers the photodiode and causes the alarm to trip.

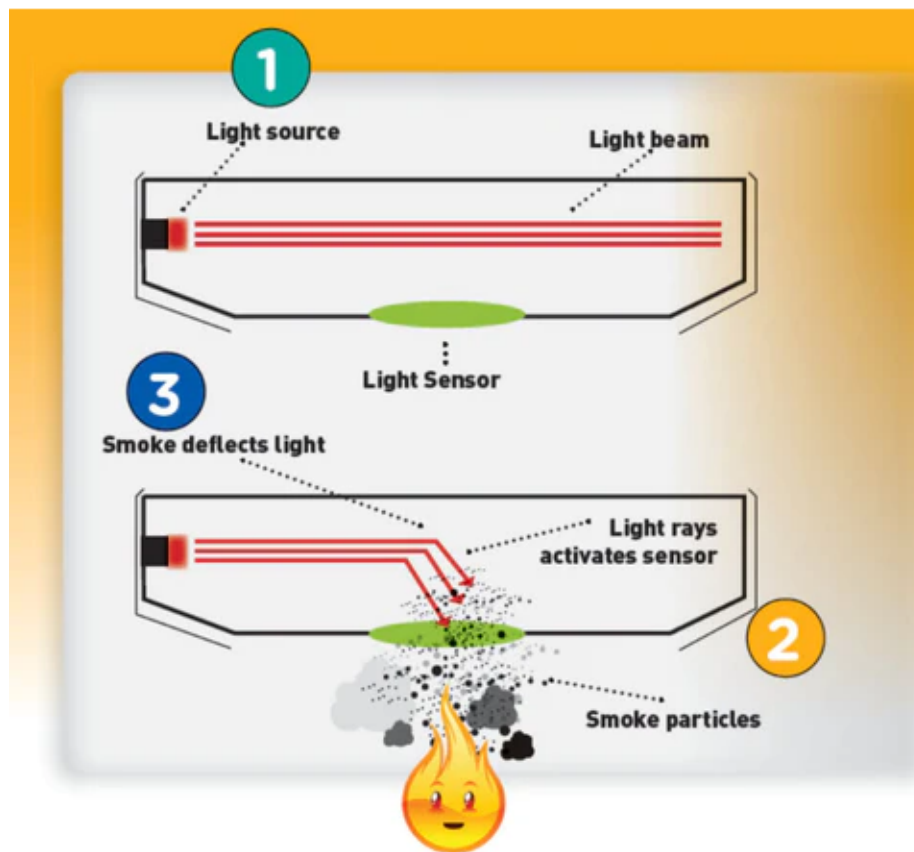

Figure 10; How an optical fire alarm works[19]

Using this principle we would be able to make an optical fire alarm that our system is based around. This would be relatively cheap and easy to implement into our project. This would add a safety feature in case the user were to manually override the computer and run the system at a higher power than is intended for that material hence creating a fire.

3.5.5 Fire Detection System Recap

As we begin designing this system a lot of questions were brought up about if this system will really ever have a purpose. This is because the computer should have safety features to keep the user from ever operating the laser at a high enough power that a fire is a risk that the system would encounter. This has left us to also consider the idea of using software to protect the user from operating the laser at a current that would be a fire risk. In the end as we start to develop and build this system we will get a better idea of exactly what system and option we plan to build. However, currently we will either use software or the optical fire alarm options as they are both cheap and should be doable assuming budgetary constraints are not an issue.

3.6 Optical Distance Measurement

Using an LED and photodetector, it is possible to perform time-of-flight response alongside an Arduino or other controller to perform the requisite calculations with precision. This would allow our system to check and see how far away the laser is from the top surface of the media, or the top of the worktable. This would allow us to move the worktable or laser in the z-direction. This would allow us to change the point that the laser is focusing too. This is important in having a highly detailed printer. Adding this functionality would allow our project to expand in scope and utility, while still having a means to keep the focus of the laser onto the top surface of the material.

If we are able to move either the material or the laser close or farther from the distance we will be able to control the spot size that is created. When creating detailed elements you would want the spot size to be at the focal point from the lens. This is important as the focal point will be the point with the smallest spot size. Being able to measure the distance between the laser and the material would allow the system to automatically adjust the laser so the spot size is the smallest.

By performing time-of-flight measurements, we could report to the system or the user how far the laser is from the material, this would allow the user or the system to fix the problem. The biggest issue we would face is if the material on the worktable is highly absorbent. This would cause the system to struggle with how much of the light is reflected. If the reflected light from the material is not strong enough to pick up and discern from noise or ambient light by the photodetector it would cause the system to be unable to measure the distance between the light source and the photodiode. One way to get around this issue would be to use a thin reflector such as a mirror or metallic material that could be temporarily placed onto the material to perform the measurements while the laser is not on. The one big issue with this idea is that the

material that is placed would need to be very thin as the system would measure from the laser to the top of this reflective material. It may be worth adding this into the program and allowing the system to realize this and account for this thin reflector.

A riskier idea, would be something like tinfoil which is fairly reflective could be formed and fitted onto the media surface if the material is not even, this would allow for a depth map could be created and passed on to the system to adjust the focus in the z-direction in real time during printing.

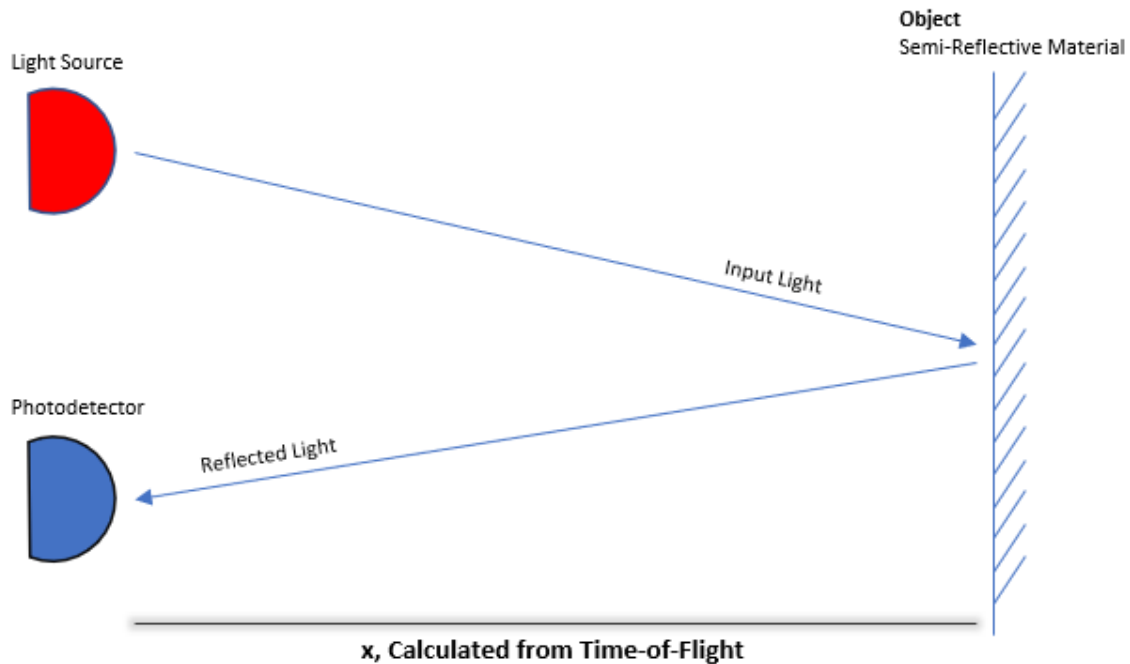

Figure 11; Time-of-Flight System Basics

Using a small laser diode and a photosensor or photodetector, we could easily recreate this system to enable our project while not compromising our budgetary constraints. Due to this we are planning to have some sort of distance monitoring happening as we believe this will improve the overall quality of the system and give the user even more control of their printer.

3.6.1 Visible Distance Sensor

For this option we will need to design a way to flash an LED. Once the LED flashes we would use a photodetector to detect how long it took for the light from the LED to travel to the material then back to the photodetector. This method would work great especially on materials that have high reflectivity. This is because most of the light would bounce back off of the material back towards the photodetector. However, this method could struggle when attempting to image materials that have a high level of absorption or dispersion. This is due to the fact that the photodetector may not be precise enough to recognise the difference between the light signal coming back and the background. To combat this one method would be to use multiple different color

LEDs, this would help if the material only absorbs certain wavelengths within the visible while still being reflective to others.

To address highly dispersive materials one solution would be to use a thin piece of metal and overlay your material with this. We would then have a setting on the printer to tell the printer how thick this sheet of metal is and measure the distance from the LED to metal. From here we can use math and tell the computer to add the thickness that this metal is to the distance. This solution while not exactly practical and easy would solve the issue.

The good thing about using visible light LED for this sensor is that your distance could be accurate down to +/-wavelength of light used. However, it should also be noted that this is assuming your microcontroller is able to process the data fast enough. If your microcontroller has any delay there will be issues in your measurement and it might be farther off. One downside would be that the visible light will have issues being readable at longer distances. This could cause issues if you go from a distance that is very far from the print platform to very close. One workaround to this would be to have a manual way to adjust the laser height to let the user get it close then adjust the last bit by using distance sensors to get the material to the focal spot

3.6.2 Infrared Distance Sensor

Another option we have is to use the exact same approach but with Infrared (IR) LEDs. The main issue with this method would be the cost, IR LEDs and photodiodes tend to be a bit more expensive. Though the cost difference would be very minimal it is worth noting. It is also worth noting that since IR light has a longer wavelength than visible, the accuracy would be worse.

Infrared distance sensors would have the positive of less background noise. This is due to the fact that when detecting in the visible spectrum you would deal with background noise from lights that are on. If you use infrared there is less of a likelihood of background noise. Some household items that could affect the photodetector would be a toaster, remote control, or an electric heater. All of these household objects use the infrared spectrum. To deal with this you would just want to take a background before turning on the infrared LED to make sure that you know if the IR LED is turned on you can measure an amplitude difference.

3.6.3 Ultrasonic Distance sensor.

Lastly you could use an ultrasonic distance sensor. These sensors work based on sending out high frequency sound waves and timing what is reflected back. These systems tend to be highly precise and work at larger distances than those of electromagnetic waves. Most of these distance sensors use frequencies higher than what humans can hear. The common frequency that is used is 40 kHz. However, these frequencies would be within the range that some animals could hear. This would be very bad especially if this printer is used around these animals. Some animals that can hear this frequency include but are not limited to ferrets, opossums, raccoons, dogs, cats, rabbits, mice, rats, and bats. It should be noted that dogs and cats are common

household pets. This means implementing an ultrasonic distance sensor into our system should not take place. Due to this we will not be using one because of the safety of these common household pets.

3.6.4 Optical Distance Measurement Recap

As we have discussed throughout this section, there are many different ways to measure the distance between two points using optics or sound. Each method has its own advantages and disadvantages. Due to this we had decided that we would proceed with attempting to measure distance using LED in the visible spectrum and photodetectors also in the visible spectrum. However, later testing told us to refocus and look into using IR LEDs to measure the distance. This is because there are a lot of options for IR distance sensors. These systems tend to be accurate down to about 1 mm. Which should have high enough accuracy for our system.

3.7 Movement and Control

This section covers our options of movement and control and the research we have done on them. To this point, we have decided that most likely we will be moving our laser diode on a flat, two axis plane above the paper we want to print on. That being said, even if that were to change in the future, the research here will stay somewhat relevant since we will likely be using the same technology anyways with just a different method of implementing it. However the idea of moving the laser up or moving the print bed to allow for printing onto other materials will be further discussed in the design section.

The main technologies being discussed here for controlling movement are stepper motors and servo motors, as well as the potential mechanical configurations that can be driven by either. DC motors were ruled out instantly due to not having much of an ability to control the movement of the motor the same way steppers and servo can be controlled. Without that movement control capability, our device would be unable to achieve the precision movement needed to achieve a printing resolution anywhere near our stretch goal of 300 DPI, let alone our base requirement of 50-100 DPI. Because we only need to explore linear actuation along a single axis, only two underlying methods of mechanical movement were researched: timing belts with gears and threaded rods with lead screws. Then, the different ways that these two methods can be configured were explored.

3.7.1 Stepper Motors

Stepper motors are motors that, similar to DC motors, induce magnetic fields with coils in order to rotate a magnetically polarized rotor. The main difference is that DC motors are only designed to rotate continuously in either direction without much control,

while stepper motors utilize several different magnetic poles and drivers to to allow control in direction, speed, and position.

The center rotor is a permanent magnet that only has two poles, a north and a south, and there are four coils surrounding the motor that will be connected to a stepper motor driver and microcontroller. The coils surrounding the center rotor are mounted on what is called a stator, which does not move. These coils can, utilizing a driver and controller, carry current in either direction and can be controlled individually rather than all at once. This allows the motor to induce a magnetic field in whatever polarity is needed at the moment. When the magnetic field induced by the coils, the rotor aligns itself to behave as magnets should, with the North pole attracted to South, and vice versa. Now, if we wanted to further rotate the rotor, then the controller would need to turn off the coils currently on, and turn on the other coils to move the rotor. Deciding which coils to use and what polarity to use them in is something done by the controller and motor driver, all of which occurs in mere fractions of a second. Repeating this process, we can achieve continuous and fluid movement, while also being able to switch directions and hold positions as needed.

There is simple math involved in calculating rotations of the stepper motor. One full rotation of the rotor equates to 360° of total angular movement. For a simple step motor with only 4 movements/positions we can calculate:

$$\frac{360^\circ}{4 \text{ steps}} = 90^\circ \text{ per step}$$

Meaning that one pulse to the stepper motor will equate to a 90° angular movement. This is a very large movement that would not really help in any scenario where precision is needed, which is why actual stepper motors typically have hundreds of poles rather than just 2. The number of steps any given stepper motor has is determined depending on the number of poles the rotor has and the number of coil electromagnets the stator has, so there is no easy way to determine the step number by just looking at a motor. Step numbers are typically given by the manufacturer, so we will be sure to look out for that information if or when we purchase stepper motors.

Typical stepper motors have hundreds of steps, even the cheaper ones. If we had a stepper motor that had 200 poles and could achieve 200 steps, the angular movement per step would be:

$$\frac{360^\circ}{200 \text{ steps}} = 1.8^\circ \text{ per step}$$

1.8° per step means just one single pulse to the stepper motor causes a very small 1.8° change in position, which is much more precise and would be actually useful in precision applications. The degrees of movement per step is inversely related to the number of steps, so as the number of steps in a motor increases, the smaller and more precise movements can be made with just one step. Granted, more poles and steps does result in a higher overall cost, so we would need to decide the tradeoffs of cost versus precision.

As useful and novel of a technology as they are, stepper motors are not perfect and do have their downsides and flaws. For example, they typically never come with encoders that can provide feedback on the motion of the rotor as they are usually open looped systems with no feedback by default. This could lead to precision errors, where

the motor, for one reason or another, fails to accurately go to its intended position, and neither us nor the controller chip would have any way of knowing it is wrong since there is no feedback. Also, stepper motors are known to have high torque at the cost of lower speeds, which can be a downside or upside depending on what it is being applied for. The table here goes into more details about stepper motor pros and cons:

Pros	Cons
1) When working as intended, we can achieve high precision with less than a degree of angular movement per pulse	1) No encode or feedback system built in can lead to precision errors that are unable to be noticed or corrected by the microcontroller or driver
2) Stepper motors are usually pretty cheap and even the low cost ones can achieve a decent precision	2) Stepper motors are not known for achieving high speeds, being beaten in maximum speed by DC motors and servo motors
3) No feedback loop can be easier to work with and more simple in installing and using the motor	3) Current constantly being pulled through the motor at all times, even if it is stationary and not rotating, which can lead to heat issues and an overall low power efficiency
4) High, consistent torque when rotating	4) Torque begins to significantly drop the higher the speed of the motor is pushed

Table 6; Pros and Cons of using a Stepper Motor

3.7.2 Servo Motors

Servo motors are devices that utilize feedback to allow precise and controlled movement. There are different types of servo motors, namely AC and DC servos that have differences that make them better for different purposes, but also can be categorized on whether they are brushed or brushless. The device itself consists of several parts, with the actual motor doing the rotating only being a portion of the entire servo device. Servo motors consist of an electric motor, a driver circuit, an encoder sensor for feedback information, and a gearbox to regulate output torque and speed. All these components are encased into one single device which are called servos, which already makes them quite more complex than a stepper or regular DC motor.

3.7.2.1 AC Servo Motors and DC Servo Motors

AC servo motors are typically more expensive and in general, more complicated than DC. Aside from having its input power be an AC sinusoidal power source, the actual speed of the AC servo motor is determined by the frequency of the voltage being applied. AC motors also usually can handle higher currents, although are less efficient than their DC counterparts.

DC servo motor speed is directly dependent on the magnitude of the DC voltage being applied to the device. The position and movement of a DC motor can be controlled with a pulse-width-modulated signal. Since most microcontrollers are able to create accurate PWM signals, this makes them excellent servos to work in microcontroller-based systems, such as our project. These servos also have a lower cost associated with them and a better power efficiency compared to AC.

In general, if servos are going to be our option for movement, then we specifically will most likely move forward with a DC servo. These servos are built for almost all applications big or small, unlike AC servo which are typically high power output meant for large industrial use. PWM signal use in DC servos work excellent with whatever microcontroller we will end up using, and since our PCB and almost all components of our device will be DC-powered, everything tells us that choosing a DC servo makes the most sense.

3.7.2.2 Brushed and Brushless Motors

Brushed and brushless motors are not necessarily a category exclusive to just servos, but just about any electric motor or device that uses electric motors.

In a brushed electric motor, the current to the motor is sent through contacts around the rotor that allow the current and consequently the magnetic field, to move the rotor. When the rotor moves, then new contacts receive the current that change the magnetic field so that the motor moves again. This repeated process will keep the motor spinning continuously. The “brushes” are the conductors that send current through the contacts as they spin around, typically made of a light, soft conductive material. This introduces friction as the brushes are constantly sliding with the contacts, which makes brushed motors and servos produce a lot of noise and some extra heat. Even so, brushed motors are cheap and incredibly affordable due to their simplicity even with the downsides of constant friction on the rotor. As another note, the majority of DC servos contain a brushed motor.

Brushless electric motors avoid the issue of friction by doing away with any sort of contact or brushes entirely. These motors instead utilize Hall Effect sensors to achieve motion, similar to stepper motors. Without brushes creating friction, these motors produce much less noise and heat, as well as have slightly higher efficiency due to no power loss caused by friction. These advantages do come with a cost, as brushless motors are almost always more expensive than brushed motors. Additionally, AC motors are usually brushless by default with some exceptions.

3.7.3 Stepper Motors vs Servo Motors

To help us with the decision of choosing between these two types of electric motor devices, we compiled a table by comparing the two on some standards we need to consider when buying them.

	Stepper Motor	Servo Motor
Speed	Most stepper motor speeds can't work past 1000 RPM without significant torque loss	Speeds at several times that of a stepper (2000-3000 RPM for even lower end servos)
Torque	Very high torque when the speed is not pushed to far high	Consistent good torque even at high speeds
Precision	Great precision for most applications	Likely better precision than stepper motors
Efficiency	Current constantly running through the stepper motor, even when not in motion, will undoubtedly lower power efficiency	Servo motors have better control over current and in turn have better power efficiency, especially DC servos which typically have around 90% efficiency
Feedback	No encoder and open-loop by default, leaves room for errors that may not be seen by controller	Built with encoders and closed-loop system by default, allows correction by the driver and controller with feedback information about the motors behavior
Affordability	Almost always the cheaper option, great performance for a reasonable cost	More expensive due to extra components in the device

Table 7; Comparing Stepper Motors and Servo Motors

When deciding between the two, the team feels that stepper motors are the best choice mainly for affordability. While servo motors can outperform in many cases, they come with a significant price increase for many bells and whistles that are probably not even necessary for our application. Through research, we have come to the conclusion that stepper motors will give us the performance we need. One of the best candidates for step motor selection is the STEPPERONLINE Nema 17 2A step motor. It has 1.8 degrees per step, which the math done in Section 3.7.1 shows that is 200 steps. A good driver can increase precision with partial steps, but we believe that 1.8 degrees per step will be good enough precision for our purposes.

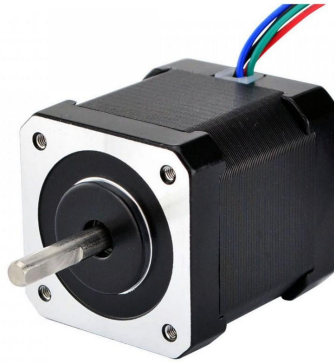

Figure 12; The Nema 17 Stepper motor that will be used in our design, for both X and Y axis movement of the laser diode.

3.7.4 Mechanical Axis Control

To be able to move the laser head across the print area, there needs to be a way of translating the rotational motion of the motors to linear motion across the X and Y axis. In conventional 3D printers and CNC machines there are two main methods of axis movement, threaded rods and timing belts. Both types of systems have advantages and disadvantages. To determine which method of axis movement is best for the system, we will look at each individually and determine their practicality. We will then examine the different possible configurations, which might include a mixture of both axis movement methods.

3.7.4.1 Threaded Rods

When connected to a motor, threaded rods can essentially extend the motor shaft along the entire axis. A lead screw on the threaded rod can then be moved along the axis. When attached to a mounting point, this enables a structure to be pushed or pulled via the lead screw. Depending on the configuration of the rest of the axis system, a guide rod may be required to run parallel to the threaded rod to keep the lead screw from rotation. If the lead screw is allowed to rotate, then whatever is attached to the mounting point loses its stability and will begin to rotate as well.

Threaded rods are commonly used in vertical axes because the lead screw is able to 'self-lock' if it cannot rotate freely. This is accomplished due to the nature of the screw, as the lead screw cannot move linearly without breaking the threads if it is unable to rotate. If motor failure occurs, the lead screw and its attached apparatus will stay in place, protecting whatever hardware is attached from falling. This will potentially be useful for the self-adjustment feature of the print bed, but will not be applicable for the laser head as no vertical movement is required. Using a threaded rod, the print bed can be adjusted once with an initial movement of the motor and then ignored, relying on the lead screw to lock in place and hold the print bed in its current position.

High positional accuracy can be achieved if backlash is accounted for in the lead screw. Backlash is when there is a gap between the teeth of the lead screw and the teeth of the threaded rod, allowing unwanted movement. Anti-backlash lead screws do exist, but may not be necessary for this application. Because the backlash of a particular lead screw can be accurately calculated using the screw and rod's dimensions, it can be reliably accounted for. If the margin is small enough to not be visible in print results, the problem of backlash can be safely ignored.

3.7.4.2 Timing Belts

Timing belts provide a cheap and efficient method for driving a linear axis.

At a minimum an axis driven by a timing belt would need two gears (or a gear and pulley set), a belt, and a guide rod. Unlike threaded rods, the guide rod is not optional due to the flexible nature of the belt. To attach our laser head to the belt, a part will have to be fashioned that will secure itself to the belt either by clamping or through attachment holes. The axis will also require a method of tensioning the belt so that no slack exists. Any slack present will introduce a large margin of error in positional control, and make accurate movement of the laser head nearly impossible.

The main benefit of using a timing belt to drive an axis is the high speed that becomes possible. Because friction is mostly only present in the gears, belts are very efficient at converting torque from the motor. Combining this with their light weight, timing belts are able to move almost as fast as the motor is able to. The exception to this would be if inertia from the load placed on the belt is high enough to break the belt. However, the laser head will not be moving fast enough for this to happen.

Another benefit of using belts in the design is their high level of configurability. Due to their flexible nature a belt can bend and twist to wrap around corners or connect to a rotated gear. Several XY axis configurations exist to take advantage of this and accurately and optimally move peripherals. These configurations will be discussed in section 3.7.4.4.

3.7.4.3 Threaded Rods vs Timing Belts

	Threaded Rod	Timing Belt
Speed	Slow, high torque needed to move faster	Very fast
Translation Efficiency	Low due to friction	High when belt slack is accounted for
Precision	Precise when backlash is accounted for	Margin of error always present, very poor precision if any slack is present in the belt

Cost Estimate (12" Axis)	\$10	\$4.25
Weight	Heavy	Very light
Torque	High torque, can lock in place naturally (drive vertical loads)	Potential for high torque when configured correctly, belt slippage might occur

Table 8; Threaded Rod vs Timing Belt design

In the table above, the cost estimate was found by quickly searching for sets that contain all the necessary parts on amazon. Because part sets on amazon are not guaranteed to be the most optimal, the parts were only being selected to see a very rough estimate of the cost difference between the two methods of axis control. The threaded rod set found contained one threaded rod, a lead screw, a stepper motor mount, and two end [] for a total of \$10. The timing belt set contained four gears and pulley sets, lock springs, four mounting points, and a 5 meter belt for \$17 dollars. At a cost of \$17 for 5 meters of timing belt, 24" would cost \$2. However, the set only includes four gear and pulley sets. This is why the cost estimate was settled at $\$17 / 4 = \4.25 .

3.7.4.4 Possible XY Axis Configurations

Given the axis control methods described in the section above, we need to combine an X axis and a Y axis so that we can accurately move the laser head across the entire print area. Two main types of configurations are viable for this project: configurations in which one axis is mounted with its control medium to another axis, or configurations in which two axes are simultaneously controlled with a singular control medium. The first type of configuration will be referred to as a 'Conjoined Independently Driven Axis' configuration. The second type of configuration is only really possible using timing belts, and open-source designs by the name of Core-XY and H-Bot already exist. Both types will be examined and compared to determine which is more viable for this project.

Conjoined Independently Driven Axis

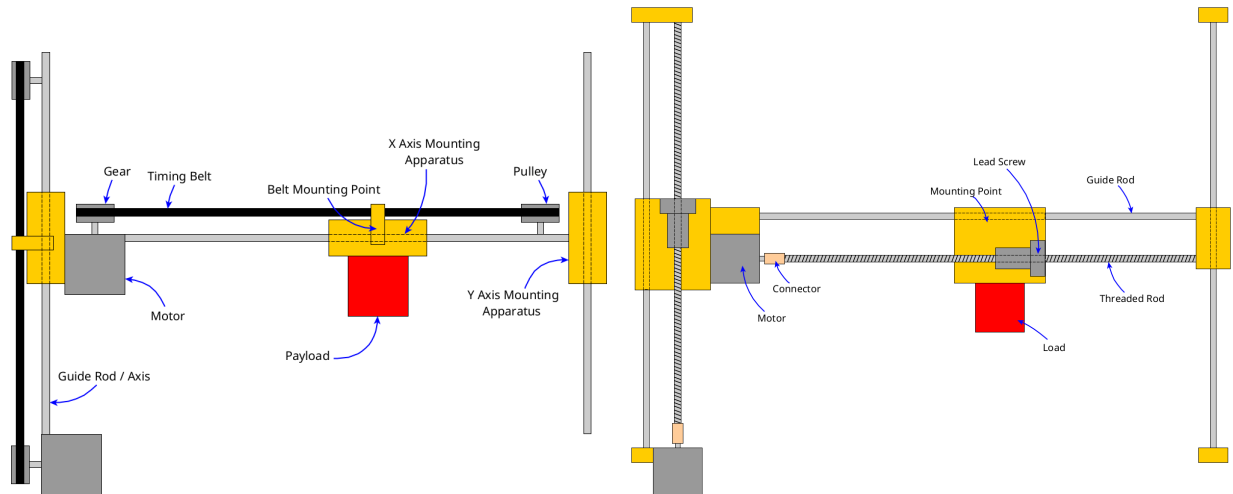

Figure 13; Conjoined Independently Driven Axis configuration for timing belts (left) and threaded rods (right)

With this type of configuration, the X-Axis is entirely mounted as the Y-axis load. Regardless of the control medium chosen (timing belts or threaded rods), the configuration is essentially the same. In the diagrams above only one motor and control medium is used to control the Y-axis, but practically both guide rods on the Y-axis might need to be driven by independent motors. This is because the torque from applying force on one end of the X-axis only has the potential to flex or rotate the X-axis, reducing precision and adding unnecessary strain to parts. Depending on part and construction quality, if the frame is rigid enough flexing could be reduced but part strain would still be present, reducing the lifetime of the system as a whole.

The benefits of this configuration is the simplicity in construction. With an adequate frame to mount the ends of the Y-axis guide rods to, constructing this type of configuration would only entail 3d-printing the mounting points and screwing everything together. Each control medium's respective parts (like pulleys or lead screws) can be bought in kits online. Even if timing belts are chosen as the control medium, tightening the belt can be done manually via the mounting points. One potential difficulty in construction is securing the wiring for the X-axis. Because the motor for the X-axis is moved with the load, the wiring must be able to move and drive the motor without getting tangled or falling into the print area. Positional accuracy with either configuration is entirely dependent on construction quality and the degree of rotation by the motors.

Core-XY and H-Bot

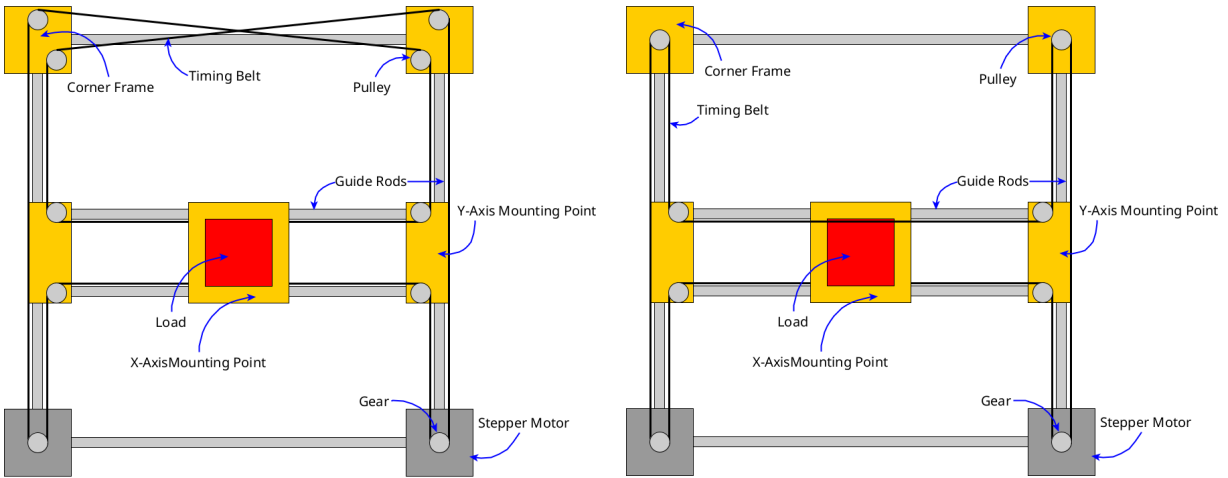

Figure 14; Core-XY belt configuration (left) and H-Bot belt configuration (right)

The Core-XY and H-Bot belt configurations are general designs that have been used in many existing 3D printers and hobbyist CNC machines. Because the motors are mounted to the Y-axis frame, they do not need to move with the load. This greatly decreases the amount of work done to move, and also reduces the complexity and amount of motor wiring needed. Control for these configurations is slightly more complicated than using conjoined independent axes, but is still fairly simple. To move the load along the X-axis, both motors need to rotate in the same direction. Because of the belt configuration, vertical forces are canceled and the load is pulled either to the left or the right depending on the direction of the motors. To move the load along the Y-axis, both motors need to rotate in opposite directions. Similar to movement along the X-axis, horizontal forces are canceled out and the load is moved vertically.

While their method of control is the same, the two different configurations apply different forces to the frame during movement along the X-axis. In the H-Bot, vertical forces are applied in opposite directions on opposite ends of the X-axis. While the vertical forces do cancel out in total, their placement causes torque to be applied on the X-axis. If the frame is not rigid enough this can cause the X-axis to flex and rotate about its center, reducing or eliminating positional accuracy of the load. The Core-XY configuration was designed to counteract this flaw. Because the belts are crossed along the top, vertical forces are applied along the same guide rod when moving the load apparatus along the X-axis. This means that no torque is applied, and no flexing can occur. Figure 15 below shows the tension forces generated on the belt for each configuration when attempting to move the load apparatus along the positive X-axis. Without having to worry about flexing we have greater liberty and room for error when using off the shelf parts to construct the frame.

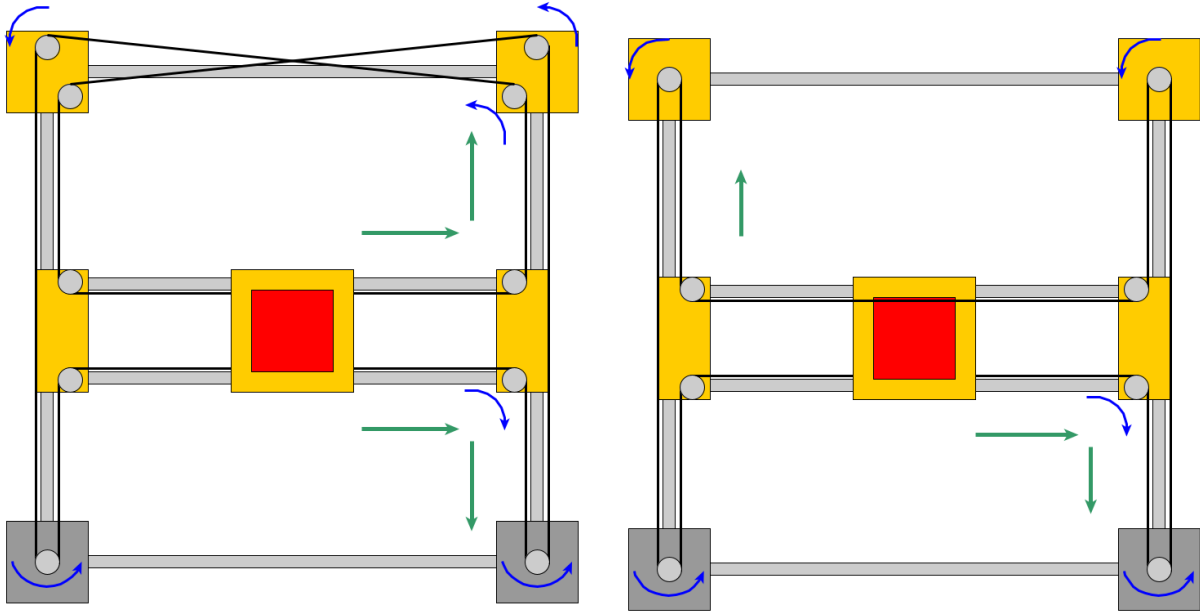

Figure 15; Tension forces (green) and Belt direction (blue) for Core-XY and H-Bot configurations when moving along the positive X-axis

3.8 Possible Architectures and Related Diagrams

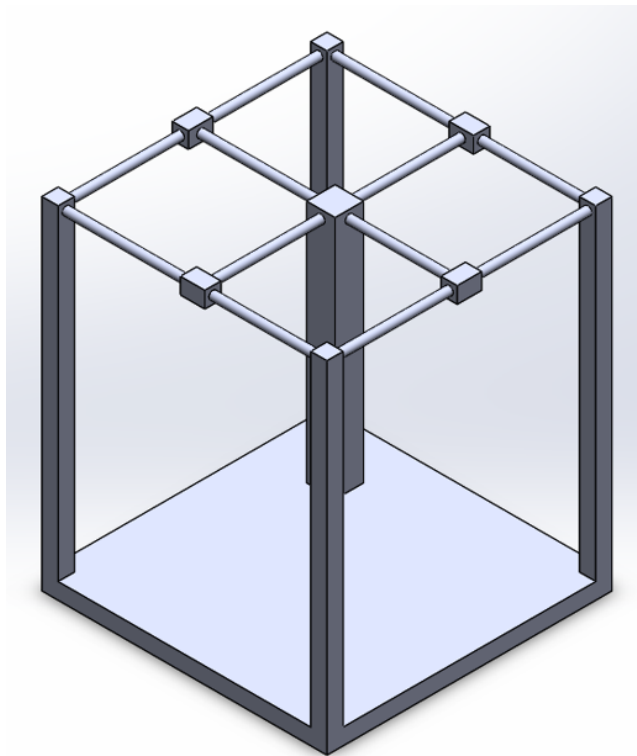

Figure 16; 3D model of what D-MILE may look like

Our first prototype mock-up for the D-MILE. The system will be 400mm x 400mm x 400mm, with the laser in the center being fully enclosed in a system that is 40mm x 40mm x 200+mm to enclose the laser and optical elements, while potentially also extending down to the print bed. The laser system will be moved in x and y by motors, while a potential z solution is being researched, but a solution would likely be either raising and lowering the worktable itself, or mounting the laser in a similar way to a 3D printer extruder, allowing for fine movement in the z-direction.

Not shown in this diagram are added features such as the power to the system and display elements, all of which are more variable. The intent behind this model was to show the rough size and ratio of the design.

3.9 Part Selection Summary

Throughout this section we will discuss the parts that were selected for our system.

3.9.1 Optical parts

There will be two lasers that will be used within our system. The first one will be a primary laser that will be important for the engraving to occur. For this laser we ended up choosing a laser engraver from amazon. Implemented into the laser is a cooling fan, This means all you must apply to the laser is power, ground, and a modulated signal if you want to modulate the laser. This laser will operate at 405 nm and has a maximum optical output power of 0.5 W. This means this laser is classified as a class 3B laser. The next laser within our system we wanted to be a red laser. This is due to the fact we didn't want there to be any confusion to the user of which laser was on. We found a 650 nm laser pointer from Digi-key for about \$10. This is a 5 mW laser. This means the laser is classified as a class 3R laser. This laser will be okay for the user to look at.

The next optical components that we needed to consider were infrared LEDs and photodetectors. For both of these optical components we will need the LED to be an emitter while the photodetector is a receiver. For the LED we found a few on Digi-key that are very cheap and we will buy a few of them to use incase of any issues in the future. The wavelength we are planning to use is 940 nm. This means the photodetector we are planning to use, also from Digi-key either the PD204-6B or PD204-6C, both have a spectral range into visible light. This means that we may run into noise issues within our system requiring us to switch to another wavelength range for the infrared LEDs and photodiodes. Both of these will be used in the distance sensing and fires detection systems.

The last section of optical components that we require will be the lenses and beam combiner. For the beam combiner we will need one that transmits wavelengths in violet while reflecting wavelengths of red. For this we will need to use something called a reverse beam combiner. This is just due to the fact that the wavelength set is the opposite of what is normally desired for what reflects and transmits. However, we have yet to find the exact part that we plan to use, because of this we may change how we plan to combine both the beams. Next we need to get two lenses that have low

absorption around 405 nm. We also want to have two lenses with a small focal distance. We ended up deciding on a N-BK7, Plano-Convex lens with a diameter of 6.35 mm, and an effective focal length of 75.6. There should be roughly a 2% reflection of light through this lens at 405 nm and 1.5% reflection at 650 nm.

3.9.2 Electrical Components

Most of our project, as with most of any project, is going to consist of several components that all have some electrical components, or are related to the function of other electrical components. The microcontroller, laser diodes, and stepper motors are just some examples. We must choose the appropriate electrical parts for our PCB to ensure that our components work, which includes power needs and data connections.

3.9.2.1 Voltage Regulator Integrated Circuits

Voltage regulation circuits and integrated circuits are going to be the main driving force for getting our components their necessary power needs. The LM317 and the LM2576 are the two integrated circuit regulators that will be seen on our board, powering several components depending on their current draw or voltage rating. The LM2576 in particular will probably only be used once and be a surface mount component. Testing has shown that this adjustable regulator does not give off as much heat as expected, so a heat sink may not be necessary. Because of this, we can opt for a surface mount component instead of a through-hole component to reduce size. The same cannot be said for the LM317, however. When the LM317 draws the same high currents tested on the LM2576, much more heat was generated. The LM317 on our PCB will not be used for high-current components, so this may not be an issue, but if the heat proves to be an issue then a through-hole component may be necessary so that a heat-sink can be more easily attached.

3.9.2.2 Basic RLC Components

For the regulators to work properly, we need several basic RLC components that serve various purposes. Inductors will only be seen in an LM2576 regulator circuit, but it will most likely be one of the larger components on our board depending on the inductance value. Even surface mount inductors can be larger than the integrated circuit they are meant to supplement. Capacitors serve as voltage spike protection on our components as well as a voltage stabilizer on a buck converter. These will also be surface mount components, but that may vary depending on the capacitance value. Smaller capacitances can usually be achieved with very tiny ceramic surface mount capacitors, while larger capacitance values will need larger surface-mounted electrolytic capacitors. Either way, capacitors on our PCB will most definitely be surface-mount components to make our PCB take up as little space as possible. Resistors will vary in

value, but most of the resistor values that will be seen on our PCB are those that can be in small, quarter-Watt surface mount resistors.

We will try to limit all RLC surface-mounted components to a 805 or 603 footprint, as those are the most common and therefore cheaper to buy. The exceptions to this will be large electrolytic capacitors, as well as the single inductor that will be on our board.

3.9.2.2.1 Diodes and LEDs

While not technically RLC components, we figured it was best to discuss part selection of diodes and LEDs here in its own sub-section.

Only one diode is expected to be used, and it will be in our LM2576 buck regulator. The MBRS360 Schottky diode is the exact part we plan to use, and will most likely be a surface mount component as most other components are.

The LEDs are used as indicator lights to help us troubleshoot if a regulator is not working. Green LEDs will be used, and most likely we will choose through-hole components for these to make the LEDs more pronounced and easier to see.

3.9.2.3 External Components

Several components in our project will be connected to our PCB, but outside of it. This includes the microcontroller and laser diode, but those are discussed more in depth in section 3.9.3 and 3.9.1 respectively. In this section of part selection, we will focus on DC fans and motors, and motor drivers.

The stepper motors that will control our CNC movement are going to be the Stepperonline NEMA-17 2A motors, and we will definitely have 2 of them minimum to each control the X and Y direction of our laser, with potentially adding a third for a Z dimension if we can achieve our stretch goal.

The DC fans that will be cooling our PCB and our laser diode can be of any reputable brand, but we will need a 30mm by 30mm by 7mm for the laser diode mounted fan. For the DC fans mounted to the PCB for general cooling of all our PCB components, we can decide between two 90mm by 90mm fans, or three 60mm by 60mm fans.

The motor drivers for our stepper motors, while we do technically plan to be on the PCB, are counted as an external component. This is because the driver itself is its own PCB with its own input and output we want to utilize. To attach this to our PCB, we will only need female 2.54mm pin header sockets to match the footprint of the driver itself. This way, we can just plug the driver directly onto the socket and it will stay on our PCB. This choice makes our board somewhat modular too, with the ability to swap out a motor driver with ease if we ever need to.

3.9.2.4 Connectors

The electrical components outside of the PCB will need connectors that are on the PCB. For most components, standard 2.54mm pin headers will serve as connectors

just fine. This includes the laser diode connector, the DC fans connectors, and the microcontroller connections. Regular jumper cables or ribbon cables can be used to complement these pin header connectors.

The only unique connector will be for the 24VDC adapter input to power the entire PCB. We will need a female DC connector that is fit for a male 5.5mm outer diameter contact and 2.5mm inner diameter contact DC connector. This female connector component will be a through-hole component on the edge of the board to ensure a strong, solid physical and electrical contact.

3.9.3 Microcontroller

For the microcontroller, we have decided to work with the STM32 microcontroller family. This decision was made mostly due to the comparison in flash storage size comparisons between the different microcontroller families under review. Another main comparison point was the pin count. While it is very unlikely to get anywhere close to using all of the GPIO pins on the microcontroller within the scope of this project, it is still desirable to have more pins. By having an excess of available GPIO pins, there is immense flexibility in the amount of motors, sensors, or lasers that we can control. By providing ourselves with this flexibility through the STM32 platform, we're accounting for any unforeseen design changes that need to take place during development and testing.

To select a microcontroller within the family, we will be selecting a development board. The main advantages of buying a development board rather than developing our own PCB is the inclusion of an on-board JTAG debugger and programmer. It also allows us to focus our time elsewhere rather than having to design and test a PCB for the MCU along with writing the firmware. Similarly, creating the project around a STM32 development board allows us to focus more time on the mechanical design, construction, and troubleshooting, which we can reasonably expect to have unforeseen challenges given that we do not have a mechanical engineering student on our team.

We have chosen to begin development with the STM32F407 device, with its corresponding development board STM32F407G-DISC1. This is within our expected budget at around \$20 without shipping. The discovery board also has many of the GPIO pins available as headers, allowing for easy prototyping and testing of firmware functions.

3.9.4 Frame and Axis Control Parts

We have decided to construct a Core-XY belt configuration for the gantry system. To build this, we will need a timing belt of adequate length, two gears, eight pulleys, four guide rods, and four linear bearings. By a very rough estimation, we can see that the timing belt in a Core-XY system runs lengthwise about eight times (assuming that the gantry is a square). Given that a piece of A4 paper is 11.7" tall, we can assume that our

gantry needs to be 12" x 12" at an absolute minimum. Using this information, we know that we must select a timing belt that is significantly longer than 8 feet, which is roughly 2.5 meters. Looking at part availability online, we can see that timing belt kits commonly come in increments of 5 meters in length. This means that we can safely select just about any timing belt and gear/pulley kit that is significantly above 2.5 meters in length.

Given that the only significant physical property that we need in parts selected is rigidity, we will simply buy the most price effective and available parts that we can find. We can safely assume that any metal part chosen will meet the level of desired rigidity because no part in the system will be under significant external force.

4. Related Standards and Design Constraints

While there is no intent of making our project a commercial or consumer product, we feel as if it makes the most sense to treat it as such. By doing so, we must try to adhere to the design and safety standards that the companies that do make consumer products also adhere to.

4.1 IPC PCB Design Standards

In 1957, multiple different circuit board manufacturing companies came together and founded the association known as the Institute for Printed Circuits (IPC). This organization designated several standards regarding printed circuit boards from design, manufacturing and production, and more. Despite the organization no longer having the original name, to this day IPC standards are used by thousands of companies when creating commercial products with PCBs, and we intend to adhere to these standards as well.

That being said, the full and complete list of IPC standards are not free and would likely cost about half the expected budget if we were to get it. This makes sense since it is expected that companies purchase and use these standards rather than a group of 4 students. Even so, plenty of summaries and general standards can be found on various sources online that we can gather information from to use.

4.1.1 IPC Product Classes

IPC standards sort electronic products using PCBs into three main product classes. Class 1 is for general electronic products whose lifespan is not expected to be long and it is not critical to be functional for an extended period of time. This class of product is typically for simple, short lifespan, regular consumer products such as headphones or a digital watch. Most consumers buy products in this class with the expectation that they likely won't last more than a year or two.

Class 2 products are labeled as "dedicated service products" by IPC. These products are held to a higher standard in regards to expected lifespan and the amount of time the devices are functioning as intended. It's not an absolute requirement that

these devices have no downtime whatsoever, but it is usually preferred by both manufacturer and consumers. Products in these classes include items such as desktop computers and air-conditioning units.

Class 3 products, the final of the list, are labeled as “high-reliability electronic products” by IPC. As the name implies, these products are held to the absolute highest standard as their application tends to be ones that reliability and a long lifespan are incredibly critical. Most of these products are not your average consumer product, rather being reserved for applications such as airplane computer systems or military-grade radar systems. Even so, that does not mean that you won’t find them on regular individuals, as devices such as pacemakers are also considered Class 3, due to how critical they are to the health and even life of a person. Products in these classes are leagues above Class 1 in terms of quality, since they cannot cut corners when most of these products are used in such critical applications where they need to last a lifetime and never have any downtime. Due to this, they tend to be the most expensive products.

The chart below can be helpful in determining what class any electronic product may fit in:

	Class 1	Class 2	Class 3
Expected Lifespan	1-3years	4-10 years, could be even longer if properly maintained	10+ years, most ideally these products should last indefinitely
Affordability	Affordable by most regular consumers and cheap enough to replace regularly if needed	Typically a one-time purchase, not something a consumer would want to replace regularly	Usually way out of a regular consumers price range, but the typical applications of these products are usually not for them
Quality	Poor to maybe decent	Decent to Good	Great to as close to Perfect as possible
Example Products	Headphones, keyboards, digital watches, cheap electronic toys	Desktop computers and laptops, AC and/or Heater Units, refrigerators	Military-grade radar systems, airplane and aeronautic computer systems, life support machines

Table 9; Comparisons and examples of IPC Product Classes

Regarding our project, the Distance-Monitored Inkless Laser Engraver, we believe that if this were to be treated as a real product classified under IPC product classes standard, we would fall under Class 2. Most regular ink or even toner and laser printers would already fall under this class due to their relatively long expected lifespan, decent quality, and reliability. We will ensure that our project best meets the standards of a Class 2 product, being something that should ideally last a few years without failure and run reliably every time without issue.

4.1.2 IPC-2221: Generic PCB Design

As mentioned previously, due to being unable to reasonably acquire the full and complete version of IPC standards, most of the information here is relying entirely on third-party sources that summarize the information, or even brief summaries, visuals, or explanations from IPC themselves.

IPC-2221 is the name of the general standard that covers almost everything regarding basic printed circuit board design. It is part of a family of documents made by IPC known as the IPC-2220 series, which covers design specifications. This includes materials of the PCB, layouts, design, physical and electrical properties, components, temperature limits, and more. This standard is the all-around, go-to standard when designing PCBs. Even this standard has sub-standards regarding more specific types of PCBs such as flex PCBs, which as the name implies, are flexible circuit boards that require more specific sub standards due to its properties. IPC-2221 standards and its sub standards can be seen in the flowchart below, consisting of the limited information from the IPC website free of charge:

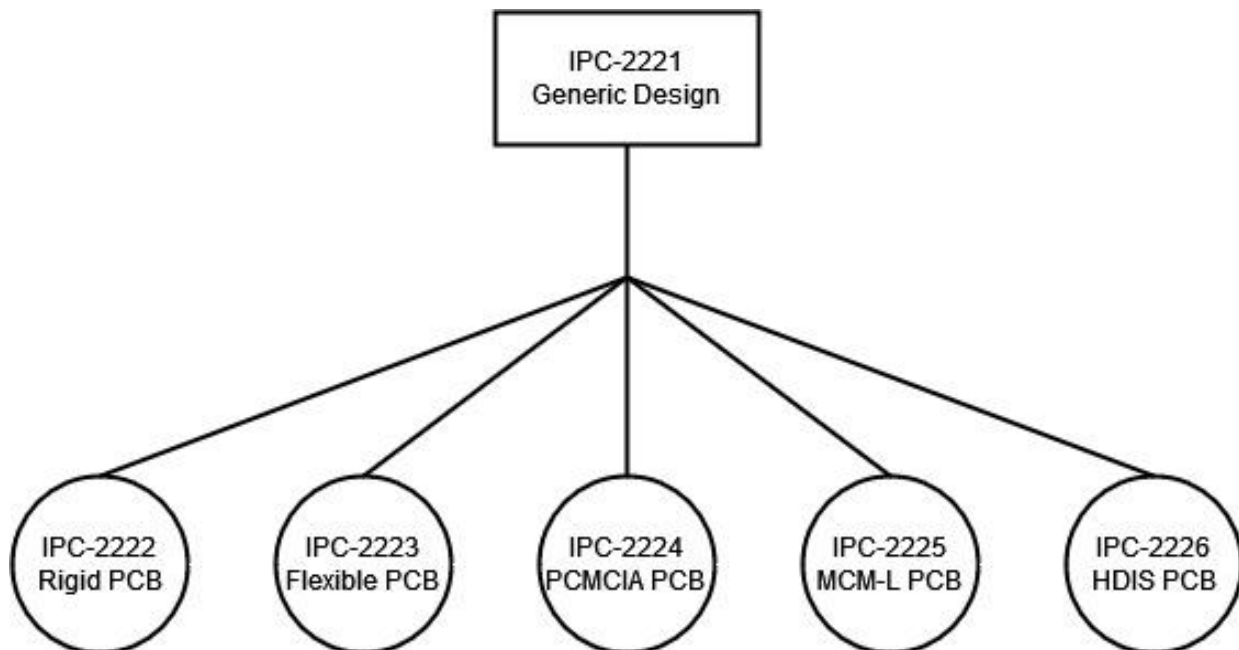

Figure 17; IPC-2221 Sub-Standards Hierarchy Flowchart

The vast majority of consumer products rarely ever match only one of these standards and very often have several types of PCBs that have to adhere to different standards. The most common in most consumer products, however, is the IPC-222 Rigid PCB standard. It is typically the cheapest to manufacture as well, but that still entirely depends on the number of components and the nature of the product you are designing. For the purposes of our project, we will best adhere to IPC-2222 standards since our mother PCB will be most closely related to a rigid PCB. We identified no need to create flexible PCBs, PCMCIA and MCM-L are also niche and not required for this project. An HDIS PCB could make things convenient to have more components on a smaller sized board, and are generally considered higher quality. However, our research shows they are typically more expensive than a rigid PCB and we've determined that the amount of components we are using is likely not going to be worth the cost to make the PCB smaller and denser.

4.2 Laser Safety Standards

There are a variety of regulations regarding lasers based on their outputs, and these regulations are governed by the ANSI-US Laser Safety Standards, and mandated as being properly labeled to the FDA's requirements. The class system for lasers is based off of a four tier system designated by roman numerals, and followed with postscripts for noteworthy conditions. They are as follows:

Class 1: The laser is safe for viewing during normal use. This means that the maximum permissible exposure limit, MPE, is not exceeded even when the laser is viewed with the naked eye or magnifying optics.

Class 1M: Similar to Class 1, these lasers are safe for viewing and do not exceed the MPE during normal use, but an exception is made for viewing with the aid of a magnification objective, in which case, the light may become hazardous.

Class 2: Class 2 lasers are safe for normal operations, but only in small doses that are naturally regulated by the human blink reflex. This means that they function identically as Class 1 lasers so long as exposure time remains less than 0.25s or as long as the light is not spatially coherent. The maximum continuous output would be 1mW.

Class 2M: Just as with Class 1M, these are Class 2 lasers that meet the aforementioned requirements so long as no magnification objective is used to image the beam onto the eye.

Class 3R: This laser class is considered safe only if handled properly, and carefully, and so long as beam viewing is restricted. These can exceed the MPE limit, but with low risks associated with doing so. The maximum continuous output would be 5mW.

Class 3B: These lasers are hazardous to the eye if direct exposure occurs, but not with regard to diffuse reflections from mundane or low-reflectance media. The maximum continuous output would be 0.5W.

Class 4: The highest laser class is reserved for all lasers which exceed the requirements listed by the Class 3B accessible emission limits outlined previously with regard to the wavelength and/or the output power of the laser based on its performance.

According to federal law designated by the FDA, all Class 4 lasers in the marketplace are required to feature a key switch and safety interlock.

Something like a normal pen laser for giving lectures would fall under Class 2 for reference, while most industrial, military, or medical lasers are Class 4. While there is no inherent restriction against using a Class 4 laser, as our laser diode would fall under as a continuous laser in the wavelength range of 400 nm to 500 nm, with a maximum output power of 0.5+ W, this does pose some major issues and concerns. The primary concern of course is safety, and the reasons for these concerns are two-fold.

The first of these concerns is in meeting with federal law. Though this product is not entering the marketplace as being part of a Senior Design project, rather than a product for purchase, it is believed by our group to be of dubious moral quality to produce a product which would be illegal if sold. As a result, a requirement for our project is to meet these FDA requirements. To that effect, we have several needs produced by these requirements to the effect of:

- Appropriate safety goggles and equipment must be worn by all members while work with construction is occurring.

- For the final result, there needs to be a kill switch for the laser on the exterior of the device to instantly stop the beam in an emergency.

- For the device, there needs to be a key switch for the power, to ensure that there is no way to accidentally turn on the device without first inserting and turning a key.

- For the device, there needs to be a safety interlock switch to prevent the operation of the laser for when the access to the engraving platform is open.

- For the device, the beam path needs to be concealed from view.

These requirements come from a mix of ANSI or FDA standards, or our groups collective moral obligations as engineers abiding to practice ethical conduct in all aspects of our career.

The secondary concern we face is one regarding fire. As we are putting a high power laser to paper, one concern we face is if the system will cause fires. Now, a goal would be to perform non-thermal ablation of paper or other materials, but to do so would require a much stronger laser, which presents both more issues of design and of economics. What is more likely is that the system we create will need some kind of prevention and detection system designed to combat thermal events within the printing space.

Part of our outlines solutions to these safety concerns are as follows:

In regards to FDA compliance, include a key switch for the printer, and a safety interlock switch to the only access point to the etching area. These will alleviate these concerns.

In regards to viewing the beam, aside from using goggles in testing, we will ensure that the beam and any stray reflections from the media inside will be isolated from view through some kind of optical shield, be it a beam tube, beam stop, or building an enclosure. Likely, more than one of these will be utilized to some capacity.

For the fire concerns, we will be closely monitoring the laser output and performing tests on different media, and clearing its use only for prior tested materials,

as well as providing appropriate warnings, but we plan on designing a secondary optical system in addition to the laser focusing design to address these concerns. See section 3.5 for details, but this would simplify to a detection system watching the etching area, and then preventing or addressing any thermal events by starving fire through the use of inert non-reactive gasses like CO₂ or any other solution that would not impede or harm the system.

4.3 IEC Power Supply Safety Standards

The International Electrotechnical Commission (IEC), is a standards organization similar to IPC that has a larger focus on power use and safety, rather than specifically PCB design. These standards are in use largely in the North American region, along with several certification companies made to actually test these standards and give certifications to products which meet said standards.

Only a few of these standards will likely apply to us, namely the ones regarding consumer power supplies, which includes products like a phone charger or a desktop computer power supply. Since we are certainly going to need a form of power supply in our project, we figured it would be best to brief ourselves with these IEC standards to be able to make a decision regarding our power supply.

4.3.1 IEC Protection Classes

The IEC categorizes power supply safety into three distinct classes, all depending on how the power supply achieves safety for the user. In a Class 1 power supply, the user is protected from electric shock through a power supplies' use of a connection to ground and a form of insulation. Class 1 is the only class where a connection to ground is a requirement, as the insulation is typically very basic compared to other classes. This basic or simple insulation will be more prone to failure compared to the other Classes, so a ground to earth is necessary to ground any extra voltage that may occur due to an insulation failure.

A Class 2 power supply is designated as such when it has double insulation and/or extra reinforced insulation. Compared to Class 1 basic insulation, Class 2 reinforced insulation offers much better protection against electric shock and it is unlikely that insulation would fail. Due to this fact, a connection to ground is not a requirement for Class 2 power supplies as the insulation is deemed effective enough at protecting the user.

The final class of power supplies, Class 3, are considered the safest due to not being inherently dangerous in the first place. These power supplies typically have a voltage limiting circuit, called a "Safety Extra-Low Voltage Circuit" by IEC (abbreviated as SELV circuits). These circuits, as the name implies, have the input connected to a circuit that limits voltage to safe levels. IEC defines hazardous voltages as above 42.2VAC or 60VDC, so a SELV circuit in a power supply must operate below these

voltages to be considered a Class 3. If the SELV circuit succeeds in this, then the power supply is considered safe and requires no extra protection such as a ground connection

4.4 Cost Constraints

One of the biggest constraints that we are facing is the fact that we do not have any sponsors. Meaning that all parts that are bought will have to be paid for by the four members of the group and split equally. This was a big discussion on how we can make sure that we get the parts that are needed for the project and that will work without going over the amount the lowest member would pay. The cost constraints applied a heavy role in choosing a laser to use for our project. This is due to the wide variety of different types of lasers that you can find and how different their applications are.

4.5 Material Constraints

While doing research onto the type of materials that our printer would be able to laser engrave onto we learned a lot about what types of materials should be used for engraving and not.

Material	Danger caused due to engraving
PVS	Emits pure chlorine gas
Polycarbonate	Will catch fire
ABS	Emits Cyanide gas
High density polyethylene	Will catch fire
Polystyrene Foam	Will catch fire
Polypropylene Foam	Will catch fire
Fiberglass	Emit fumes
Coated Carbon Fiber	Emits noxious fumes

Table 10; Materials that cannot be cut or engraved due to hazards

It should be noted that most of these materials that you should never engrave or cut are due to them being a mix of two types of different materials. This tends to cause reactions when not properly handled. This list is very important to keep in mind when designing this project and while marketing the printer. Among this list, one of the most notable issues this brings about is the

There is also a large list of materials that you are able to engrave. The following table consists of some of the notable materials.

Material	Max thickness	Notes
Wood	1/4"	Avoid any oily types
Plywood	1/4"	May contain glue
Cork	1/4"	Avoid thick corks
Depron foam	1/4"	Monitor while engraving
Paper	NA	Cuts well
Cardboard	NA	Monitor for fire

Table 11; Notable materials for engraving

It should be noted that the above materials can also be cut using a laser. However, the following list cannot be cut but can be used for engraving. This is important to realize as a consumer of the product because what you may use for engraving, you cannot use while engraving. These are two very different processes and need to be well defined. The following table consists of the materials that can be engraved but cannot be cut.

Material	Notes
Glass	Only flat glass
Anodized Aluminum	Evaporates the anodization
Painted metals	Evaporates the paint
Stones	Run at 50% speed
Ceramic Tiles	NA

Table 12; Uncuttable materials that can be engraved

5. Project Hardware and Software Design Details

Throughout this section we will discuss the hardware as well as the software design details that will be used when prototyping. This will consist of overall design options as well as options for the optical, electrical and software.

5.1 Overall Design Options

Throughout this part we will recap and discuss the overall design options we had going into the project.

Trade Offs	Main Drawbacks	Essential Requirement
Accuracy	Greater accuracy sets limits on the speed of the laser, and requires more quality parts which increase cost.	A priority to get out spot size requirements and maximum engraving depth values.
Speed	Being too slow would cause varied engravement depths along the medium, potential fire hazard if the laser is running too long, or too long in a given spot. Being too fast may result in uneven engravement, runs the risk of not being up to quality.	A priority to get our ease of use to be desirable and minimize the risk of hazards occuring or exceeding temperature controls.
Power	Increased Power Consumption increases the power demand of the system, could cause issues Increased power means greater risk of exceeding depth values or temperature restrictions.	A requirement for engraving within our spot size
Ease of Use	Increasing ease of use, i.e. creating a better interface or decreasing overall size puts more strain on the rest of the design.	A requirement to make the project viable, it needs to be at least as good as a typical printer in how it is to interface with.
Cost	Project is entirely out of pocket, so the higher cost of each component is a higher cost to each individual involved. Key parts may be paywalled behind an accessible price point, so a worse alternative may be needed.	A requirement to actually creating the project as parts are needed and certain features essential for function.

Table 13; Trade Offs for Design Options

5.1.1 Laser Optical Design Options

There are many different design aspects that must be considered from the optical design side. One of the major focuses was the laser power, the optical design used to focus the laser, and what type of laser we should use. Within this section we will break down each of these aspects of our optical design and how we plan to design around the issues.

5.1.1.1 Optical Design Used to Focus the Laser

One of the big parts of the optical design options is to determine how and where to mount the laser. The laser can be mounted vertically and moved about the grid, but this limits us to smaller, less heavy lasers. The laser could also be on a much stronger x-y translation grid.

Another option that we could consider would be to couple the laser light into fiber optic cable. This would allow us to move the end of the fiber on the x-y translation grid and be able to print onto the paper from the fiber. The main downside to fiber would most likely be due to coupling losses that occur when you attempt to couple light into a fiber. This is known as coupling efficiency, this tends to be about 60% for single mode fibers and 80% for multimode fibers. The other downside to fiber is that given we are planning to be operating at about 400 - 450 nm we would need to find a fiber that is able to operate at this wavelength without significant internal losses.

The final option that we came up with was that we could collimate the beam and then be able to use mirrors to move the beam directly to the x-y translation grid. From there we can have a mirror facing down and a lens to focus the light. The main issue with this approach would be that given we will most likely be using a class 3 or class 4 laser we would need to find a way to safely protect the beam and have it covered at all times during this process. This would involve a lot of shielding and we would need to spec this shielding to make sure it is able to handle the beam hitting it directly.

5.1.1.2 Laser Power and How to Control it

Next the laser power controlling is another design option that we must look into and consider. We can start with a cheap, low power laser and build an optical amplifier to increase the light output from milliwatts to watts. The main downside to this process would be that to start with it would be very cheap and would enable easy mounting of the laser. This is because the laser would be small and not super heavily. This would allow the laser to be mounted almost anywhere without having to design anything major to overcome the issue of weight. However in the end it would result in a costly and very complicated lens design system to create an optical amplifier.

The next option we looked into was that we could get a laser with higher output power than what we are required to have, for this case we will say 10+ W, which would be more expensive on the laser side of it. From here we can use either filters or polarizers to cut power of the laser beam. The main issue with this is that if we want this

to be user friendly we would need to make it quick and easy for the user to change the power output of the beam when switching mediums. Using filters would be an option but it would take a lot of testing and money to figure out exactly what filter to use for each medium. This would not be an issue in industry as they would have the product that they will sell but given that this most likely will never make it into the market we would spend a lot of time buying and testing different filters to lower the end power of the beam.

However, we could also develop a system to monitor the output power and then decrease input power to the correct amount so the laser can cut the material at the correct speed and power. This is most likely what we will end up doing as it would take time to test but once you figure out the input power to the laser it should be relatively easy to switch within the software that would be available to the user. This would definitely help the user from the user interface side.

5.1.1.3 Different types of lasers

There are many many different laser types that we can buy. This was discussed extensively in section 3.4.1. One of the big things that must be considered when buying a laser is the operating wavelength. This is important so you know exactly the power within the beam is. As you increase wavelength the amount of energy decreases. This means with lower wavelengths you are able to operate at a lower power while still having the same energy as you may with a higher powered system at a larger wavelength.

Next we need to look at the different optical power outputs, and the major deciding factor on the exact laser we buy will be based on economics as we have a limited budget and lasers used in engraving and other similar applications tend to be very expensive.

Another choice we have to consider would be the beam profile. This is because we can either choose to use a gaussian or a top hat beam shape. Ideally, we would use a top hat which would result in a spot size that has consistent power distribution over the entire area we are attempting to engrave on. However, a Gaussian would be much better if you are looking to cut through the entire piece of paper. This is because it would leave a more consistent flow of material on the edges. This would help eliminate any issue where the user runs their hand along the paper and ends up cutting themselves due to a sharp edge on the paper. This is a major part of our optical design as it pertains to the safety of the user and cannot be overlooked in the slightest. The user's safety should be the main consideration at every step of the design and never overlooked for any reason.

5.1.2 Electrical Design Options

The motor system design and controlling is a big design feature that must be thought through. Most likely we will settle on using stepper motors to control the movement of the laser on its rails. Stepper motors are able to be controlled quite easily with microcontroller data inputs, and a motor controller of some sort would be necessary

to provide the appropriate power signals to the motors themselves. Our motors will have to be able to make precise enough movements to allow our laser to print and engrave in great detail.

For power distribution, there are many options to consider. As of now we believe the majority of our components will be using DC power, so it should be simple enough to buy a regular adapter to plug into a standard wall outlet to power our device. We need to distribute this power to quite a few components however, this includes: our laser, motor controllers (and by association the motors), a microcontroller or microprocessor, a display, a distance sensor, and other minor components. Ideally, most of this power distribution circuitry would be on a single PCB, allowing us to simply plug an AC adapter from a wall outlet to our device and everything that needs power will get power without needing any more connections.

The Printed Circuit Board plays a major role in whether or not our project works. Our hope is to have one single, probably somewhat large PCB that houses all our power distributions to all necessary components, as well as containing whatever microcontroller or microprocessor we end up choosing to run most of our computations. Having a single PCB with as many components that can reasonably be on it will significantly reduce the size that electrical components will take, rather than having loose wires running about, or separate microcontroller development boards that take up too much extra room. Having many components on a PCB will mean we need a fan cooling system to cool all those components running at once on a single board.

5.1.3 Computational Design Options

To process images, a program can be written on an external computer that will then send data to the printer that can be directly interpreted into control signals. This way a multitude of different algorithms or preexisting software can be used to process the image without having to worry about microcontroller processing power. The other design option would be to program the microcontroller firmware to process a limited amount of simple common data types, like .txt, .png, or .jpg. Doing this would likely be computationally heavy but would greatly increase ease of use for the system. Computational cost could be spread out by only processing and printing specific zones of the image at a time, so that the microcontroller can load as much of the image as its memory will allow. Most likely we will be designing the first approach, and attempting to implement the latter approach in later updates to the firmware if time allows in Senior Design 2.

A user interface can either be done using a GUI program on an external computer or using an onboard display and buttons. Using a GUI program will make it easier to add more complicated features and will most likely cut down on hardware development time, but will require a more robust communication protocol between the printer and the computer. Using an onboard display will decrease software development time, and will not be too expensive depending on the display model and information chosen to be displayed. The downside of using a hardware display only in the system is the amount of information that you can display at once.

5.2 Laser Design

For the laser design of our system we are planning to use a 405 nm laser diode that will have an output power below 500mW. This laser will be able to engrave onto many different materials as it operates at lower wavelength, high frequency. This means that the laser is able to run at a lower output power as a laser of lower frequency. Throughout this section we will discuss the laser and optical setup that this laser will use to achieve the goals and objectives we have set.

5.2.1 Focusing the Beam

For our focus, we will make use of a series of lenses to optimize the beam spot size down to our desired resolution. These will have a focus on viability and ease of use. Ideally, we could've used any lens of any size and focused using those, however, smaller lenses would require us to create a suitable mount for them, and while 3D printed mounts are easy to create and easier to use, if the laser came into contact with 3D printer filament, the resultant burning would release carcinogenic gas into the air, which is a blatant safety hazard. As such, smaller lenses are less viable to mount. Instead, we can use standard mounts for 12.7mm lenses, which work better for our scenario. Those these tend to have longer focal lengths, the project can easily ensure that the total distance from the laser diode to the focus spot is somewhere within the 100-300mm range. Running off of our second draft of lens design through Zemax, we can achieve this through the use of two SPX062AR.4 Planoconvex lenses.

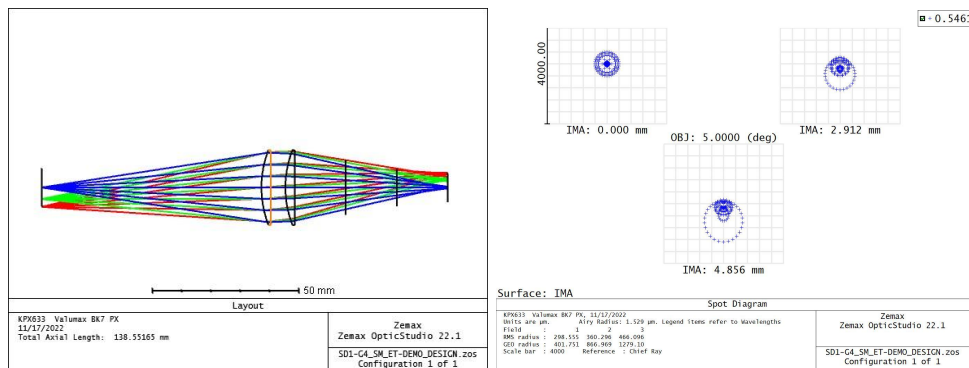

Figure 14, Lens design

This results in a spot size we're happy with and a manageable path length. To mount these lenses, we'll use lens holders and a large tube, either pre-purchased or purchased made of a heavy absorber like non-reflective metal or other such specific material to prevent light from entering or exiting the optical system from anywhere but the output/bottom.

5.3 Fire Safety Design

Fire safety for this project begins with prevention, compiled within the document are strict guidelines on acceptable materials and the risks associated with laser light coming into contact with them. By making ourselves aware of these, we can prevent issues before they start.

Beyond prevention, we have drafted several ideas regarding prevention or detection systems using optical components. However, we also will discuss the software side and how the software should be designed in a way to stop the user from ever putting the system into a state where a fire starting is a risk.

From the optical side, the simplest and more feasible of these would be an optical fire alarm setup, using a small laser diode, a photodetector, and cavity to easily be able to detect the presence of smoke in the work area, and trigger an alarm. This is further explained in its own section, 3.5.4.

To work on implementing this into our system we plan to have both an infrared LED and a photodiode. These two components would not have direct line of sight. This will allow us to use the properties of smoke to be able to detect if smoke has been produced due to a fire starting. Due to the fact that while engraving there fumes could be released from the material, once the photodiode is triggered we will stop the laser and give the system a few seconds to determine if there is an actual fire or not. This will help with false positives being eliminated due to natural fumes from engraving onto different types of materials. The following figure is a rough schematic of how we would mount both the infrared LED and the photodiode so they do not ever have direct line of sight.

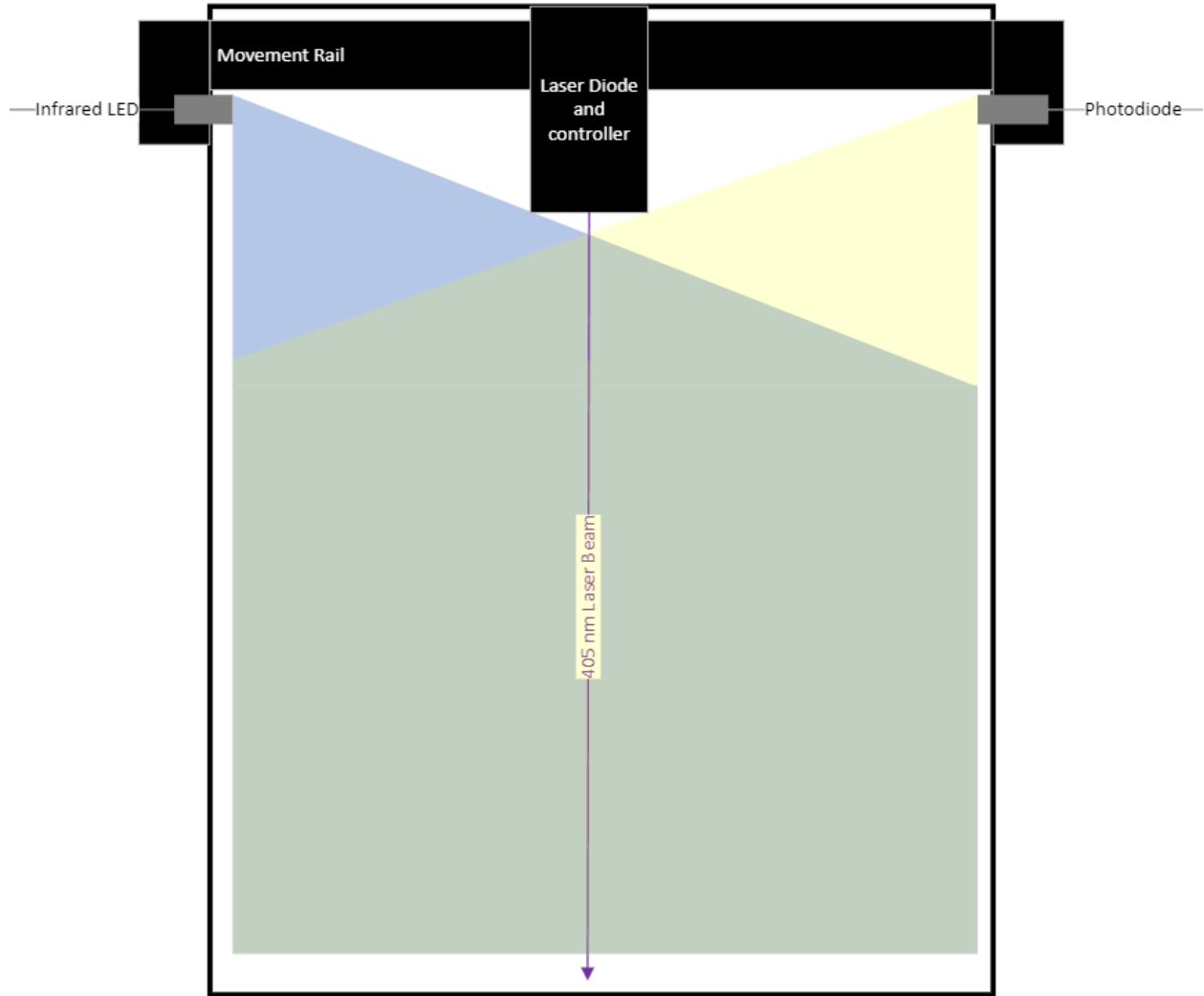

Figure 19; Schematic of how a fire safety system could be designed for our system

It should be noted that if any smoke is produced by the system it will cause the infrared LED light to be redirected into the photodiode causing the system to trip. After talking about the creation of this system there were concerns about using infrared LEDs if we don't end up enclosing the system. To deal with this concern we discussed how we will use the software as a failsafe and not allow the user to go above a certain current on the laser. Going above this current will require the user to manually override the system. This means the user knows, understands, and accepts the risks that higher output power of the laser could cause.

Both of these options would allow us to create a system that is safe and does not have a fire risk. This is important as it will fulfill the safety engineering requirement that we have for our project. The creation of a safe system should always be one of the most important aspects of the system.

5.4 Other Optic Design Components

There are many other optical components we have ideas for within this project. However, we are not sure which of them are achievable and viable. Due to this we will list the design that we plan to use for each of these side systems. It should be noted some of them may not be implemented into the final project as there are time and budgetary constraints. However, assuming neither of these existed these systems would be a great addition to the project.

5.4.1 Optical Depth Measurement

For this system we have two different options. We can do a time of flight using a microcontroller to flash an LED and then having a photodetector detect when that light is picked up. The LED and photodetector cannot have direct line of sight. The next idea is to use sound waves. However as discussed in section 3.6, we will not be using sound waves due to the problems that ultrasonic distance sensors have with animals. These systems are known as a time of flight approach to measuring distances.

We have decided that we will attempt to do distance sensing using visible light. This is because we believe this is one of the safest methods that can also give us enough accuracy that we will be able to adjust the laser close to the correct height that the focal spot will be on the material. It should be noted that if the accuracy that is achieved isn't high enough to measure paper ~0.05-10 mm, then we will say anything within the range of error will be focused as if it was paper. This will mean the resolution isn't as high on these prints but we are willing to sacrifice resolution in this case.

As discussed in section 3.6, we were originally planning to make use of visible LEDs. However, as we have attempted to do more research into this, it is becoming more apparent that the system would be easier to accomplish using infrared LEDs and an infrared detector. For this reason we will be switching to infrared LEDs and photodetectors. The main downside is that they are a bit more expensive, however, we believe the benefits that these LEDs will provide in depth resolution and accuracy outweighs the small price increase that is associated with using them.

This method would require you to measure the time from when the LED is turned on (T_1) to when the photodetector measures a response (T_2). From here you will be able to use a simple math equation to measure the distance (D) from the LED or Photodetector to the material $D = \frac{c*(T_2 - T_1)}{2}$ where c is the speed of light ($2.998*10^8$). This will give you the distance from the photodetector to the surface of the material. From here depending on where we mount this in relation to our laser we may need to add or subtract a constant to get the distance from the laser to the material. From here we can tell the system to move the laser up or down to put the laser's focal point onto the material.

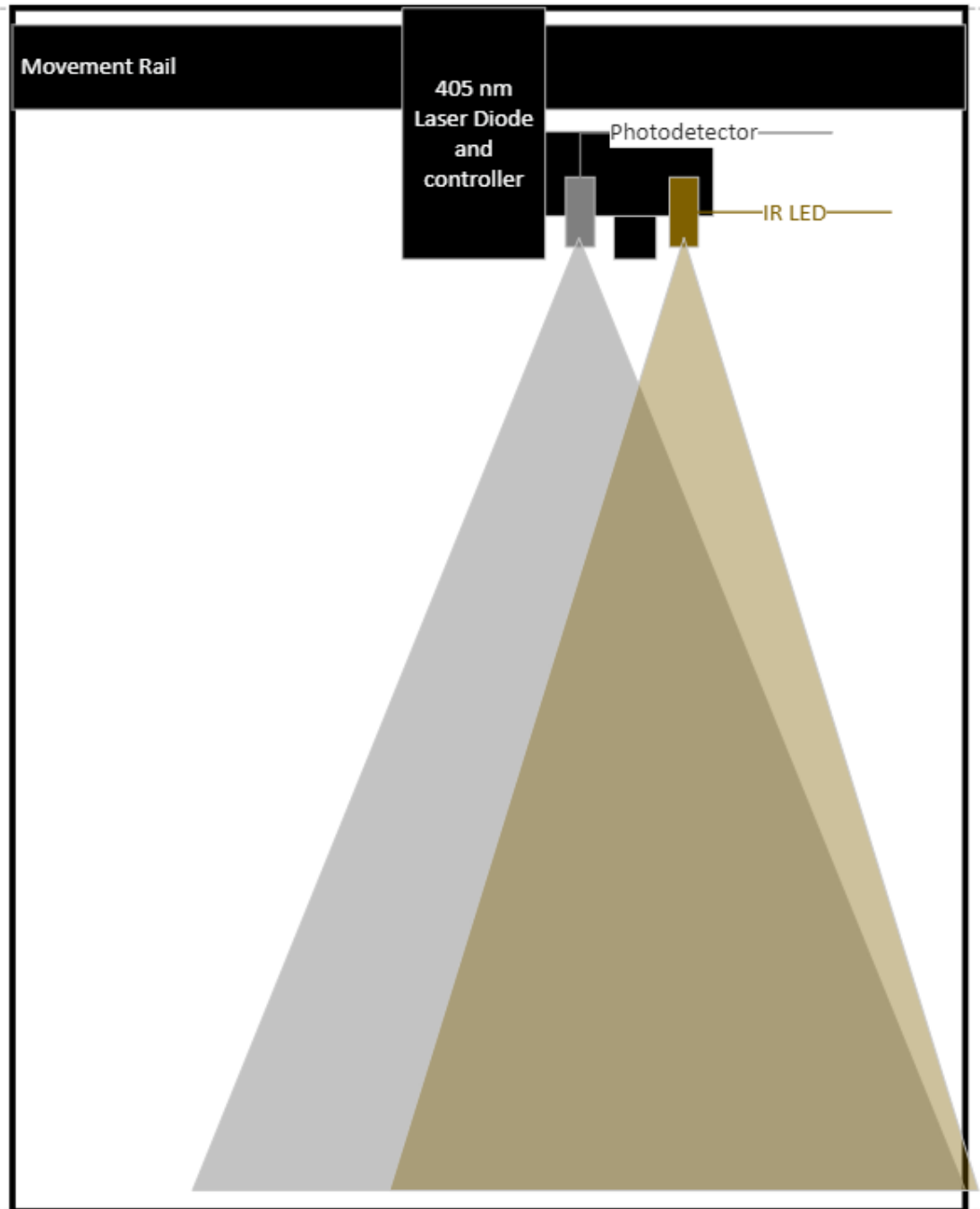

Figure 20; Diagram of how the time of flight method would work

5.4.2 Optical Workspace Detection

This system was not originally a plan but was a recent addition to the project as we have been talking about features we believe would make the system better. This is a relatively simple feature. When you turn the printer on it will give you an option to view

the printing area onto the material you are printing. As seen in the figure below the purpose of this system would just be used for telling the user where the edge of the print is with a visible laser.

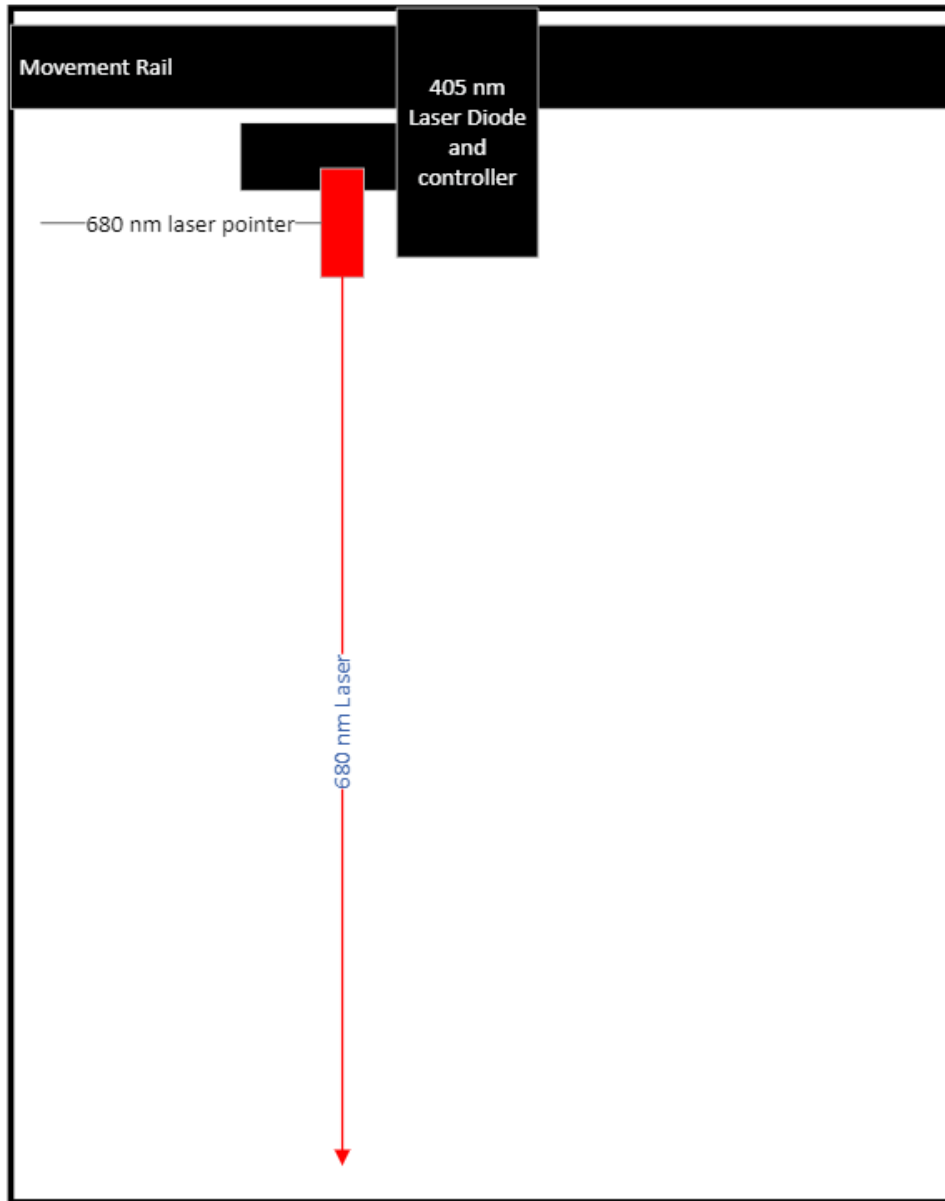

Figure 21, Optical Workspace Detection System mounting option 1

Ideally this laser would only be on when the 405 nm laser is not on. There will be a failsafe to make sure that the 405 nm laser cannot turn on at any point within this process. This will protect the user from hurting themselves by looking at the engraving laser or burning themselves of it. The system will know how far off the laser pointer is from the engraving laser. Another option for mounting the laser would be using a beam combiner and focusing both the lasers to the same point. This would be ideal for the x-y stage to not have to compensate for this issue. If this method is chosen the optical

setup would look like the following figure. It would be important to combine the two beams as close as possible to perfect so that the red laser pointer beam will shine as close to the actual beam as possible. There is one issue with this method which is we would need to make sure the 405 nm laser is covered as given its a class 3B laser. This means we would need to design something that keeps the laser covered during printing but can be removed before the print to check location.

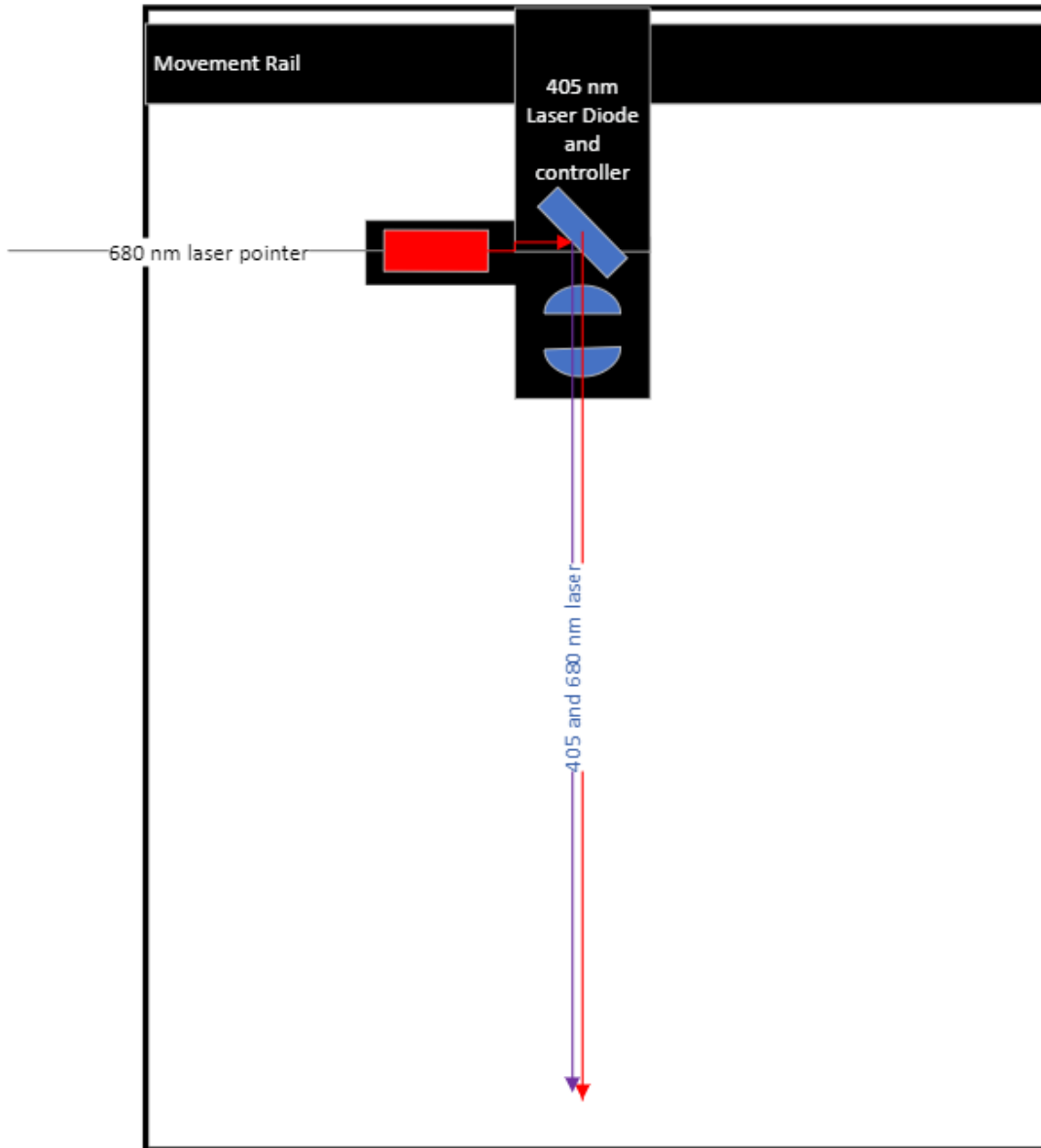

Figure 22; Optical Workspace Detection System mounting option 2

From here it will be able to travel along the x-y stage and highlight points at the edges of the print area that the user has selected. This would let the user make sure there is material under all corners. With this information it will help the user decide if

they want to continue with the print or move the material first. This should stop any instances where the print is too small/large, or the printer going off of the material and engraving on something it isn't supposed to engrave.

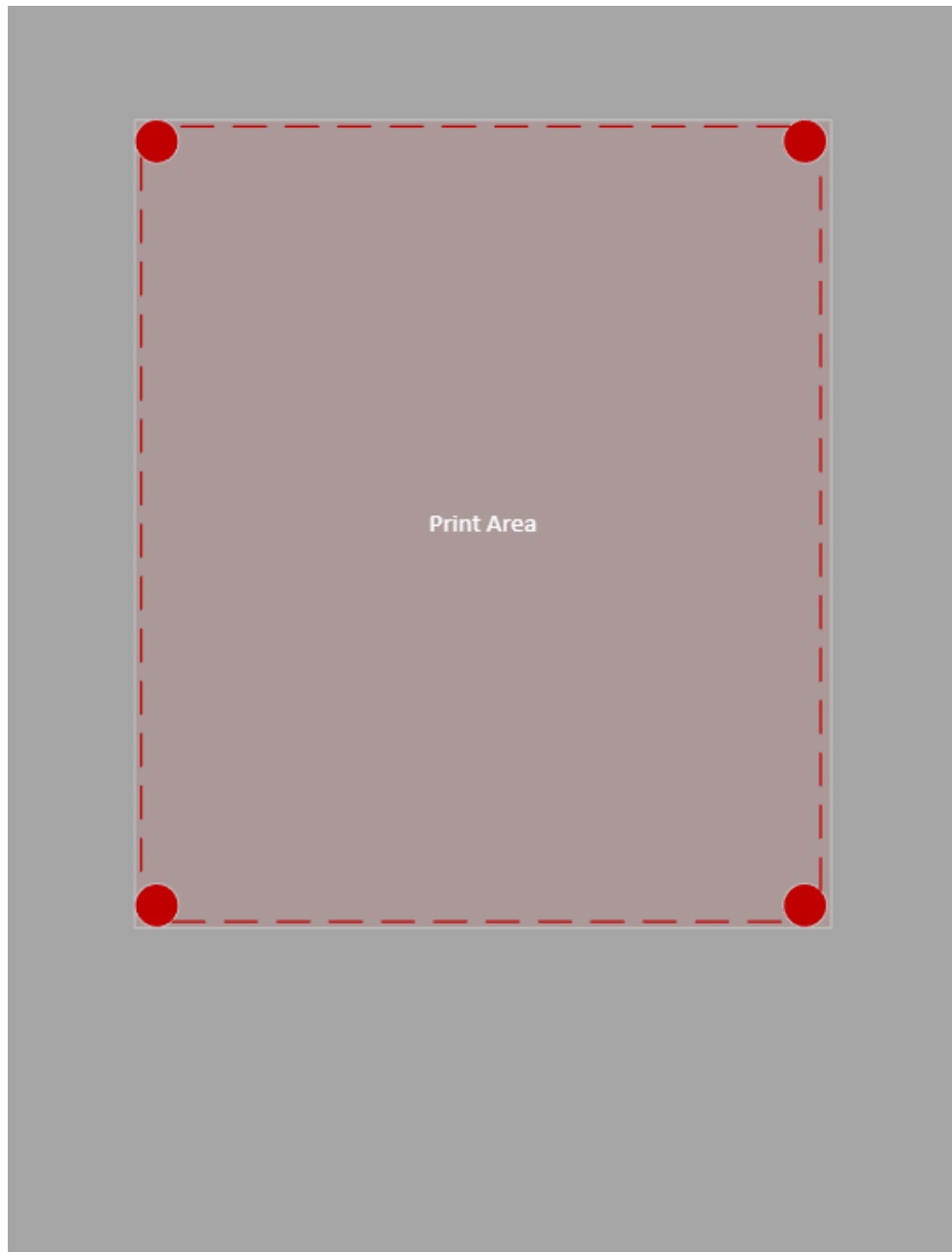

Figure 23; Example of how the system may move along the dotted lines to each corner

The above figure shows an example of how the print area (red square) that is outlined by the laser pointer could be determined. This could be done on any material before a print is started. This will allow the user to easily center the print on whatever medium they are using.

5.5 Hardware Design

5.5.1 PCB Design

Our goal is to create one single PCB that all components of our device will be connected to and should receive power and data signals all through the PCB.

5.5.1.2 High-Level Design Flowchart

Designing the final PCB is difficult to do from scratch since we are still experimenting with devices and have not made all the final decisions of what devices will be a part of our project and what will not. Devices each have their own unique connections, pins, power ratings, and other specifications that make it difficult to create a circuit schematic design without fear of changing any given device later and having to start over. Therefore, we figured it was in our best interest to create a very high-level design of what our PCB will generally consist of, leaving room for the exact devices being used to be chosen later. This chart will aid us when creating the actual circuit schematic for our PCB, and consequently the final board design of the PCB.

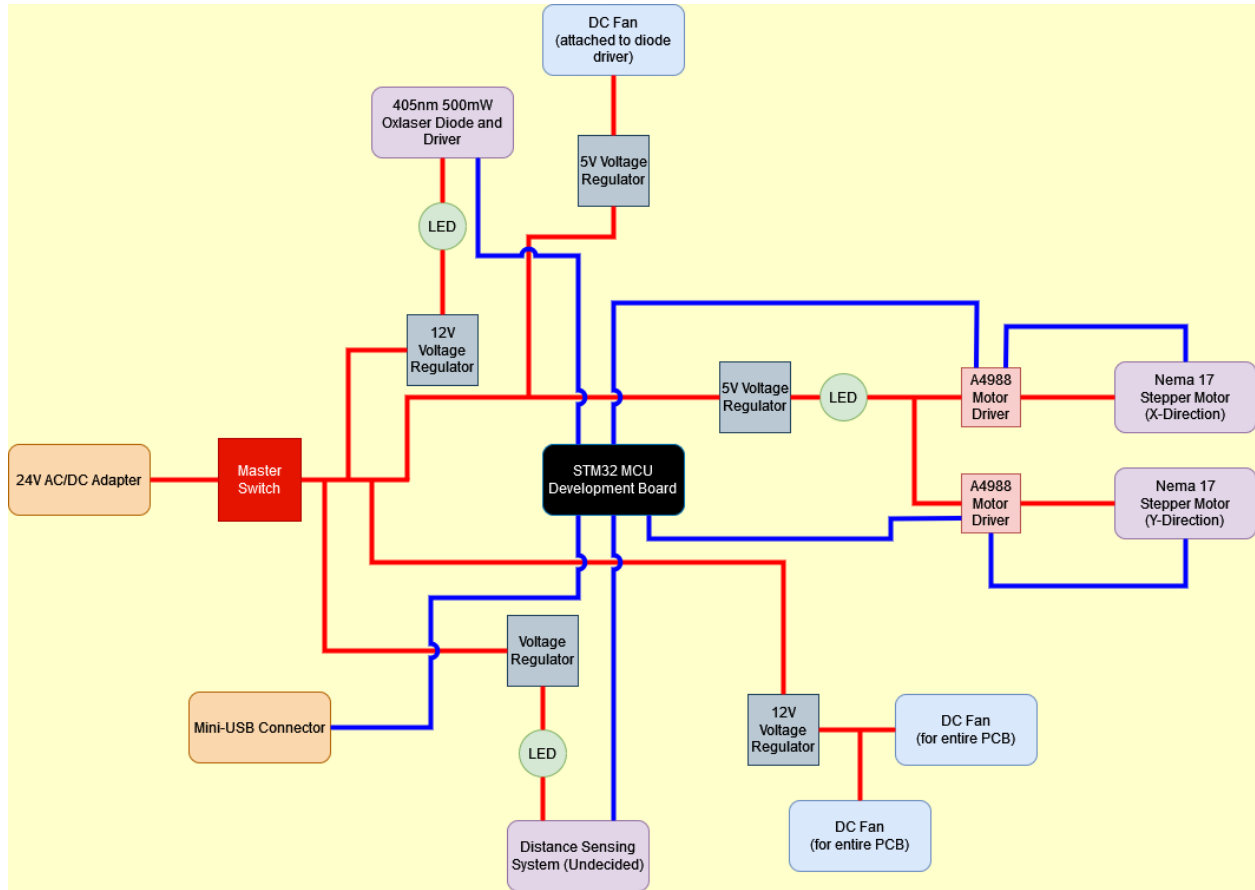

Figure 24; High-Level Design Flowchart

This chart describes all the components that will be in our schematic and PCB at a high, general level. For example, nodes labeled “Voltage Regulator” are as vague as they are since it is not clear at the moment exactly what device we are using it for, therefore it must remain vague what voltage exactly we are regulating it at.

To go into more detail about our chart, we should note that the red lines are there to represent power connections, and the blue lines denote data connections for communication, pulse-width modulated signals, etc. These connection descriptions are very general, and often do not translate exactly to an actual electrical connection. For example, the micro-controllers connection to the motor driver in reality will most likely consist of four to five pins and connections, but for simplicity's sake the chart shows just one to show the relationship. Our microcontroller, through the PCB, will be connected to the motor driver for motor control. Two of these connections must be made since we have two motors for the X and Y connection. The microcontroller will also be connected to the distance sensing system so that it can communicate with the device and gather its measurements and information. Another connection for the microcontroller will be for the laser diode. The laser diode we currently have selected is able to have its power output controlled with a PWM signal, so this connection is necessary to tune the power to what we need it to be.

For the power connections, some of the devices use a voltage regulator of arbitrary voltage value. These regulators will have actual values associated with them in

the final design, but will be absent for this chart. One thing we want to note is the existence of several LEDs attached to our voltage regulators. These LEDs are there only for the purpose of troubleshooting, as any LEDs that are off may indicate a regulator not working and therefore a component that is not receiving the power it needs. Components that have obvious indicators of function, such as a microcontroller's development boards LEDs or DC fans, will not have these extra LEDs connected to their regulators.

5.5.1.3 Voltage Regulator Design Options

There are several ways to design voltage regulators, and we need to choose the best one for this project. Most of our PCB will be containing nothing but voltage regulation devices or components to compliment the voltage regulation devices. This section covers briefly our design options and simulations, as well as analyzing and justifying our best options.

5.5.1.3.1 Voltage Divider as a Regulator

Voltage divider circuits are the most basic method of voltage regulation available, and they use the least components and are generally the cheapest. Under the assumption that our AC adapter will be outputting a 24V output, which means a 24V input for our PCB, we can simulate the following circuit:

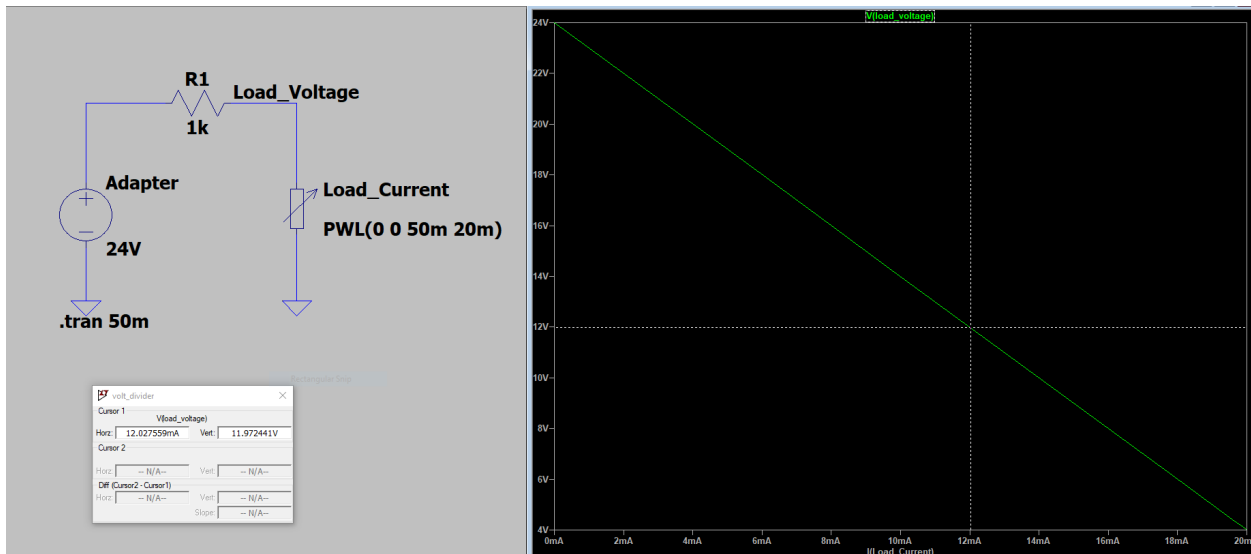

Figure 25; Voltage Divider Regulator schematic and transient simulation, variable voltage output and 0-20mA load range

To simulate a voltage divider as a regulator, a variable load takes place as the load resistor so that we can see the range of output current we can use before our regulator becomes useless. With a 24V DC input from our adapter and a 1kOhm resistor to help divide the voltage, we can test the behavior of the output as the load

current increases. If we wanted to achieve a 12V output, which is what several of our devices operate on, including our laser diode, the most current our load can draw is 12mA at 12V. Any more than 12mA, our divider is unable to maintain 12V.

This is an issue because our laser diode requires significantly more currents, as during device testing our team discovered that the laser diode can draw up to nearly 300mA when operating. Voltage dividers alone are not an efficient regulator as the resistors dissipate too much power, but when in use in combination of other regulators (such as the LM317), this circuit can be useful.

5.5.1.3.2 Zener Diode Regulator

Zener diodes are also helpful in creating voltage regulation circuits. In their most basic form, they only require one extra component added to the voltage divider circuit. Zener diodes have a property of maintaining a steady voltage (determined by their breakdown voltage) even with a varying output load current, making it already more useful than a voltage divider alone. The following shows a simulated zener diode regulator and the behavior of the output voltage as output current increases:

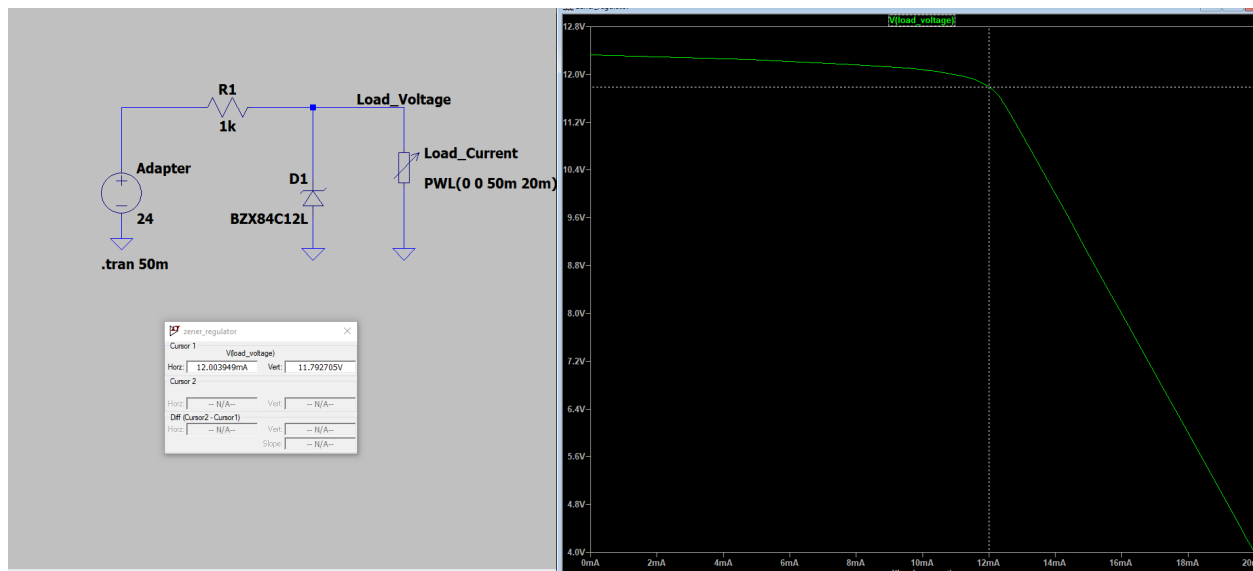

Figure 26; Zener Regulator schematic and transient simulation, 12V output and 0-20mA load range

The diode in the simulation was specifically chosen for the fact that its breakdown voltage was 12V, so we could expect a 12V output. As the simulation shows, the output voltage is actually much more steady at around 12V at low currents, but as soon as the load draws more than 12mA the regulator output drops too much to be useful as a 12V regulator.

The ability to maintain a steady 12V output at low currents can be useful for any devices within our project that do not require high current. A zener regulator is a very low cost, simple voltage regulator, with the only downside being its inability to operate at high currents. For any low current devices in our final design, for example some

temperature sensors require current draw in the micro-Amps region, this regulator design will be a fitting selection.

5.5.1.3.3 LM317 Adjustable Voltage Regulator

The LM317 is an integrated circuit chip that allows for linear voltage regulation that can be adjusted with the use of resistors. The resistors themselves are set-up in such a way similar to a voltage divider, which allows us to set our own output voltage without suffering the power loss a voltage divider alone gives us. With the following equation:

$$\text{Output Voltage} = 1.25\left(1 + \frac{R2}{R1}\right)$$

We calculate the resistor values for our 12V regulator design to be R1 as 240Ohm and R2 as 2064Ohm. The 240Ohm resistor was selected because during our research it seems that this is the most recommended value for R1, and R2 can be found just by assuming our output voltage goal is 12V and R1 is 240Ohm. Due to potential power loss due to heat, it was decided that it would be better to select a slightly higher value resistor to not risk dropping below our ideal 12V output. The next highest resistor in the E-series is 2.2kOhm, so that was the one selected for our simulation and likely our final design. Additional capacitors are added in the output and input to smooth out any potential voltage spikes and protect our circuit, which is considered good practice in general and we will certainly be applying it in most parts of our final PCB. The following image shows our simulation results for our design of a 12V regulator using an LM317:

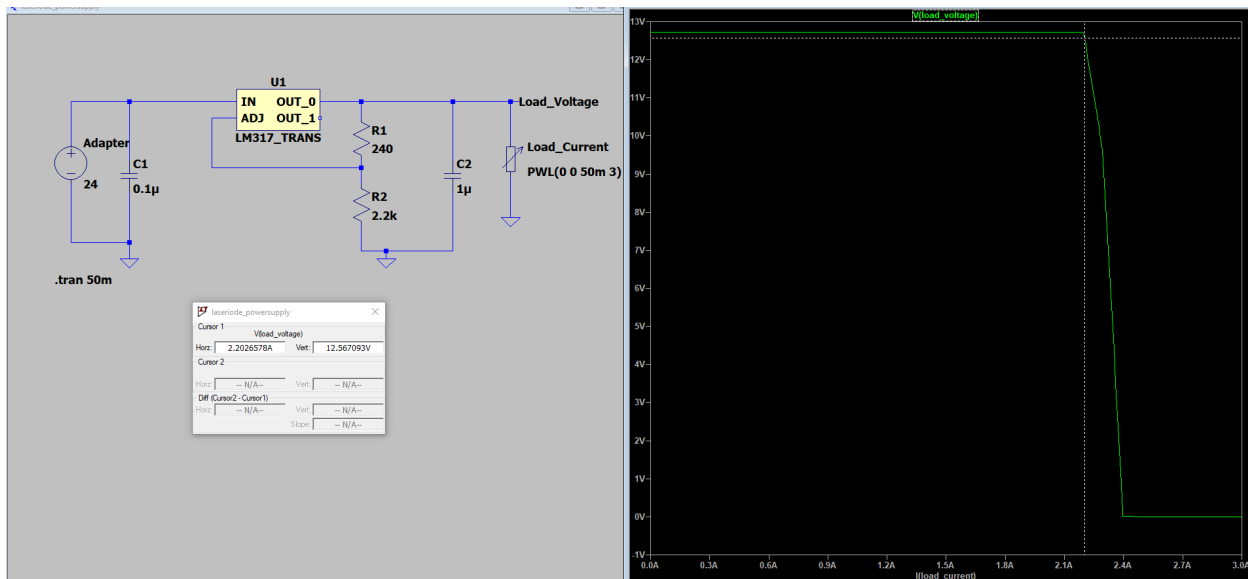

Figure 27; LM317 Adjustable Regulator output schematic and transient simulation, 12V output and 0-3A load range

This 12V regulator design outperforms the others discussed in power and the amount of load current it can output. Due to selecting a slightly higher value resistor

than calculated, the output voltage is closer to 12.7V, but with more testing we will see if this will work fine for our application or we need to reassess which resistors we use. As the plot on the right shows, the voltage begins to drop significantly only after the load draws over 2.2A. Most devices, even high-current draw ones, in our project will not even go near this threshold, making this a great option for powering a significant portion of the devices used in our project.

This regulator, as we have planned currently, will see itself powering the DC fans that will cool the PCB system as a whole as well as specific elements not attached to the PCB that need cooling such as the laser diode. The LM317, as a basic and simple linear voltage regulator, is not going to be able to output high currents and keep the most consistent voltage output as something like a switching regulator would, but regular DC fans do not need a precise voltage or high amounts of current to operate just fine. The DC fans we currently plan to use will be 12V, like the circuit we simulated, but this can be subject to change. The adjustable nature of the LM317 will make it easy to change our desired output voltage if needed.

5.5.1.3.4 LM2576 Adjustable Voltage Regulator

The last type of regulator we are planning to add onto our PCB design is a switching regulator, more specifically a buck converter and not a boost converter since we do not expect any devices to be using any voltages higher than the planned 24VDC adapter input. A switching regulator such as the LM2576 is typically able to output higher, more consistent power than a linear regulator such as the LM317. Since we have chosen the adjustable version of this regulator, the datasheet provides us with the following equation to select resistor values to achieve a 12V output in the regulator:

$$R2 = R1 \left(\frac{\text{Desired Output Voltage}}{1.23} - 1 \right)$$

Since it is recommended that R1 be a low value between 1kOhm to 5kOhm, we choose a 1kOhm value and with our desired output to be 12V, the rating for the laser driver and diode, R2 turns out to be exactly 8756Ohm. For the time being, R2 will be 9.1kOhm which is the closest next resistor value in the common E-series or resistors. This will result in a voltage higher than exactly 12V, but if this proves to be an issue in the future then we can adjust this regulator by simply replacing the resistors. The capacitors, inductors, and diode are also chosen based off the instructions of the datasheet, but they are rough estimates and once again may be changed for different value components if needed. The capacitors on both the input and output are both 470uF, both of which are there to smooth potentially dangerous voltage spikes as well as hold charge to maintain a consistent voltage on the output. The inductor's reverse-EMF properties are also necessary in the function of any switching converter, and the datasheet recommends around 100uH, so we went with that decision. The diode must be chosen to have a breakdown voltage of at least 1.25 times the input voltage (in our case, this is 30V), as well as having its current rated for at least the expected load current (around 3A for the LM2576, although we are almost certain we will not be going anywhere near this value of load current). We currently have the

MBRS360 Schottky diode selected, which meets both of the requirements. With the components selected, our simulation for the regulator shows the output voltage behavior as the load current increases from 0 to 10A:

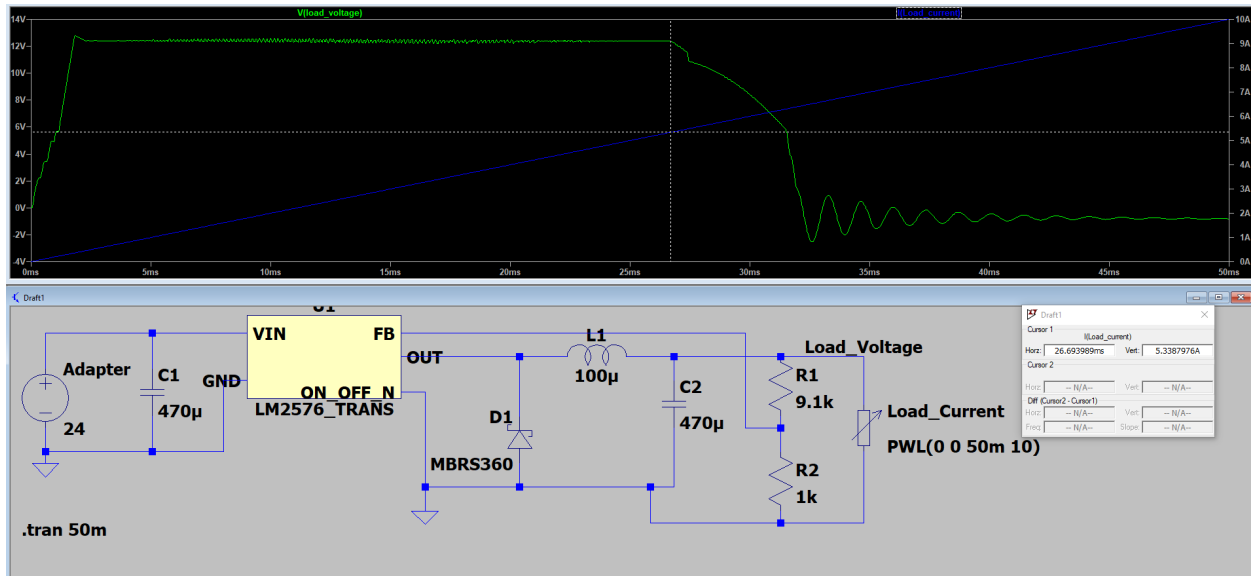

Figure 28; LM2576 Adjustable Switching Regulator schematic and transient simulation, 12V output and 0-10A load range

The regulator can consistently output just a little over 12V until the load begins drawing more than 5.3A. This power output is by far the most efficient and effective one of all the voltage regulators we are incorporating into our project so far. Due to this, this regulator will be used in powering our laser diode. Currently, the diode driver we have selected is rated for a 12V and 5A input, but through lab testing and measurements we have discovered that even operating at full power the diode driver never drew more than approximately 400mA, which is well in the operating range of this circuit as the simulations prove. Switching regulators such as the LM2576 are able to output high currents and keep more precise and consistent voltage outputs, at the cost of more parts meaning more expenses. Ordering the LM2576 and actually testing it in a lab will help us make more decisions, especially regarding the heat it will give off. 400mA output on a small IC like this will cause a significant amount of heat, so if we are adding this to our PCB then we need to decide what size heatsink to choose that won't compromise the size of the PCB or other parts.

5.5.1.4 DC Fans

The fans on this PCB are necessary to keep our entire system cool and avoid the risk of overheating. Overheating may not only cause burns or dangerous fires, but even in minor cases they will impact the efficiency of our devices on the PCB. The LM317, for example, is a pretty reliable and simple regulator, but it generates quite a lot of heat. When the LM317 integrated chip gets too hot, it struggles keeping the voltage at the intended regulated voltage. A heat sink is a good solution, which we do indeed plan on

using if needed, but even so we need a way to cool the heat sink. DC fans ensure the air continuously moves through our PCB and heatsinks to constantly cool our devices.

5.5.1.4.1 Laser Diode Driver DC Fan

When selecting a fan, we need to determine where it is going to be and that will help us decide the size. In the flowchart from Section 5.5.1.2, we intended to have fans for the PCB as a whole and one for the laser diode driver itself. The driver and diode cannot be with the rest of the PCB since it needs to move around in order for our device to function, so it needs its own fans to keep cool especially since it is one of the devices that will be drawing the most current. The diode and driver we have selected right now come as one device, and it is about 30mm by 30mm by 83mm. On the 30mm by 30mm side, the driver circuitry is on that plane and is the one responsible for being the current-source for the diode. With the screws and hole on the corners of the devices, it is designed to perfectly house a 30mm by 30mm brushless DC fan. Through research most of the 30mm by 30mm DC fans we have looked into range from a 3V-5V input with few being a 12V input. We will go with a low 5V brushless DC fan since the higher power options are most likely not going to be necessary, and with less power comes less noise which is a plus. This means that we will need a 5V voltage regulator for the fan, which will be made from an adjustable LM317 or zener diode regulator, or a combination of the two if necessary and depending on the current draw of the fan.

5.5.1.4.2 Perpendicular PCB DC Fans

The PCB will also have DC fans placed perpendicular to it to force air to flow all the way throughout the surface. These ones will have to be larger and more powerful than the small one we are placing on the laser diode driver. Without a fully realized PCB design, we can only estimate how large we need a fan or how many. Two separate 90mm by 90mm DC brushless fans are an estimate of what we will need. If this were our option, we would need a 12V regulator to control both fans, only one for both. This can be either the LM317 or LM2576 design, depending on how much current both fans will draw.

If two 90mm by 90mm DC fans prove to be too tall, we can instead choose to have three 60mm by 60mm fans. The total distance they will cover standing side by side will remain 180mm, but with less height it will fit better on our device and won't stick out as much or will be as intrusive. These 60mm by 60mm DC fans will also run on a 12V regulator.

5.5.1.5 Indicator LEDs

The LEDs shown on the chart on Section 5.5.1.2 exist for what they are named, as indicators that the voltage regulators are indeed working and outputting power. If any given LED is off, it will be easy to trouble-shoot and find out what went wrong with a

regulator due to the indicator. Microcontroller development boards typically have their own LED that indicates function, so as of now it does not appear necessary to add an indicator LED to the microcontroller input voltage. DC fans are inherently obvious to tell when they are functioning and receiving power, so as of now our design won't include indicator LEDs for the DC fans.

We are choosing green LEDs, which electrical properties differ depending on the exact model. On average, however, they typically have a forward voltage drop of 2V to 3V and emit bright enough light at a 20mA current. Assuming these values, we can use:

$$R = \frac{\text{Source Voltage} - \text{LED Voltage Drop}}{\text{LED ON Current}}$$

To select our values for the resistor that we must connect in series with the LED. The series connection of the LED and resistor will be connected in parallel with the load of whatever device the regulator is regulating. For example, for our 12V switching regulator that we designed to power our laser diode driver, using the equation and Ohms Law our resistor value is somewhere between 450Ohms to 500Ohms depending on whether the voltage drop of the LED is closer to 2V or 3V. For the simulation, we chose 500Ohms and will use this resistor on our PCB unless through testing and probing we discover that we should change it. Simulating the indicator LED on LTspice, we get the following result:

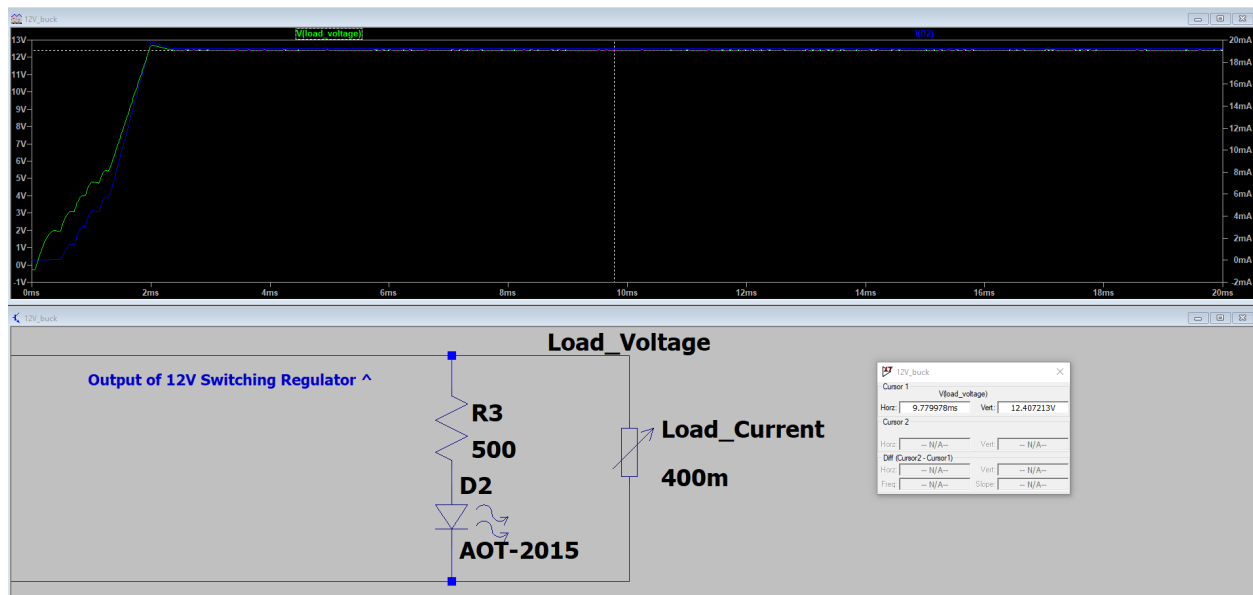

Figure 29; 20mA LED on 12V switching regulator output, transient simulation showing both LED current and output voltage

As the transient simulation result shows, the current draw of the diode that will be our LED is just under 20mA, which should still emit light just fine. The added 20mA of current draw will mean our regulator circuits will have to output more current than just the load, but as long as we choose the proper resistors for each diode and voltage this should not be an issue. This regulator is already running 400mA on the load representing our laser diode, and as the simulation shows the extra 20mA being drawn

from the diode does not affect the output in any significant way. For the case of a 5V regulator for the smaller DC fans discussed in Section 5.5.1.4.1, an appropriate resistor value would be 100Ohms to 200Ohms.

5.5.1.6 Motor Driver and Stepper Motor Connections

The motor driver we currently have selected is the A4988 step motor driver. This driver will be the main controlling circuitry for the step motors as it is necessary for them to function as intended. The microcontroller will not be directly connected to the stepper motor, rather instead connected to the driver and the driver controls the motor. The driver will need a 5V input, which means we will need a 5V voltage regulator on our PCB for the drivers made from LM317. If possible, we can create one single 5V regulator for both drivers (for the X and Y direction step motors), but if testing this shows that too much heat is generated or the regulator cannot keep up with current draw, then we can instead use two separate 5V regulators. The A4988 driver is itself a small PCB module with male, straight pin headers with the standard 2.54mm distance between pins. To incorporate it into our own PCB, we will use female pin header sockets with the same standard 2.54mm distance between sockets. This will allow us to plug in the A4988 driver directly to our PCB without the risk of soldering a small circuit, as well as make our design somewhat modular. Now, we can replace the driver if needed just by taking it out and replacing it with another in the socket. This same design choice will be discussed later with the microcontroller.

The stepper motors will be connected to the A4988 driver once the driver is connected to the power it needs and the microcontroller. The step motor that will be used is the STEPPERONLINE Nema 17 2A step motor. 2A is the absolute maximum current rating and we should not be running these motors anywhere near this value at any point our device is working. The motors themselves will only be connected directly to the driver, but with our PCB we will use traces with the pins on the driver to make a connector for the motors. This means we will have to be aware of the locations of circuit components on the PCB, placing connectors somewhere around the edge where it will hopefully be more convenient to plug in the step motors.

5.5.1.7 Laser Diode and Driver Connection

The laser diode and driver come as one single device for convenience, and it is the OxLasers 405nm, 500mW purple laser. It runs on 12V, so we will need a 12V regulator. We can say with certainty that the LM2576, 12V switching regulator designed in Section 5.5.1.3.4 will be the choice of regulator for this diode, since it is going to be one of our higher-current drawing devices and the LM2576 will be the best choice to handle outputting that power. That makes two pins, the 12V regulator output and the ground pin, that need to lead to the PCB.

The third pin and only other pin on the driver is a PWM signal pin. The STM32, our current microcontroller of choice, is able to output PWM signals in various frequencies, but that design philosophy is not covered in this section. Whichever pin in

the STM32 is the one going outputting PWM needs to have a PCB trace and connector to the laser diode driver. If connected properly, the laser should work and the output power should be controlled by the PWM signal from the microcontroller, however we would like it to be programmed.

5.5.1.8 Emergency/Master Switch

This component is very straightforward and the most simple feature of our PCB. A switch that controls the power for the entire PCB. On the chart, this switch is connected to the 24V input from the adapter. If for some reason there is a need to immediately and manually disconnect everything from power, the switch should be in a convenient place to turn off the PCB entirely by just toggling the switch. By default, this switch will be left closed as a short assuming everything runs as normal, only needing to be turned off if manual intervention is absolutely needed.

The M2011S2A1W01 toggle switch by NKK should be the appropriate choice for this feature, it has a maximum voltage and current rating of 30VDC and 3A, which we should be operating under so the switch should have no issue conducting as normal when closed as a short.

5.5.1.9 STM32 Microcontroller Connections

The microcontroller we will be using in our design, the STM32, will be programmed in a development board like most microcontrollers are. We will, for the sake of ease of use and installation, be keeping the microcontroller on its development board in our final design. The development board, as it is currently, has standard 2.54mm pin headers in an orientation that would make it difficult to plug into sockets connected onto the board, similar to what we are planning to do with the A9844 drivers. It is possible to reverse the pins by de-soldering and soldering again, but we decided not to risk making a potentially damaging mistake doing that. Also, since not all the pins are going to actually be in use, we figured it is cheaper and easier to not add several unnecessary vias and sockets that are not connected to anything to our PCB. The development board will have connections to the PCB for sure, but it will instead be through several jumper cables and/or ribbon cables that connect directly from the microcontroller to the PCB, and the PCB will have the appropriate traces to connect the STM32 digital logic and data signals to where they need to be (motor driver, diode PWM, etc.)

The microcontroller itself will be powered by USB by computer, which it already has to be connected to anyways since that will be our main interface for using our project to actually print text. Researching this development board informed us that the 5V rail on the board is the same as the 5V input from the USB input, and without protection in place, we should not connect to both USB and external power supply at the same time. The microcontroller will be in its own place somewhere outside the PCB connected to the computer with the interface, and with cables we connect the specific

pins in use of our microcontroller to the PCB, which then will trace them to their appropriate connection.

Since the STM32 development board has standard 2.54mm pins, we can select multi-pin, dual female jumper cables for the pins on the development board, and on the PCB we have the same 2.54mm standard male pins to connect them to. We will ensure that the PCB will have each pin connection labeled with the exact same pin on the development board, which will make set-up and connection quick and easy.

5.5.1.10 Distance Sensing System

Due to being a recent decision to add this feature, it is difficult to provide details about how this system will be applied to our PCB. Section 5.4.1 discusses several options of distance measurement and their purpose, if they end up in our final design at all. Here, we will assume this system will show up on our final project and how it relates to our PCB and electrical design.

Whatever distance sensing system we have, whether it is one single integrated device or several devices, will need its own voltage regulator. With the several voltage regulator options that will be appearing on our PCB and covered previously, this will not be an issue. Such a system will inherently have components existing outside of the PCB however, since the distance measuring has to be done on the platform on which the medium of printing is occurring. The solution for this is the same as the diode and motors, that being jumper cables that connect to our PCB and long enough to reach the necessary components. This has to be done not only for power regulator connections, but data and logic signals as well. A distance sensing system is no use without a way to communicate and gather information from MCU to our interface, so those connections will be necessary too, however many pins that may end up being.

5.5.1.11 External Connections

Referring to the chart on Section 5.5.1.2 there are two components that are a “dead-end” of sorts, relating to connections that are not exactly part of the PCB. While the names are self-explanatory, it is best to speak about them in detail the same way we have described all the other components and systems on our PCB.

5.5.1.11.1 24V AC/DC Adapter

One of our goals was to have our device be able to be plugged into and powered by any 120VAC, 60HZ, U.S. standard wall outlet. If we wanted a true challenge we could directly connect the AC power to our PCB and create an entire step-down transformer, full-bridge rectifier, smoothing regulator circuit, and the works. This would likely generate a lot of unnecessary heat on our PCB and would probably be very difficult to get right, so instead we will opt for purchasing a regular 24V, 5A AC/DC adapter. This makes schematic design a lot more simple and less time consuming,

since we can just assume adapter power to be a regular voltage source and not the complex power circuitry that it actually is. Also, this option is much safer since we will be sure to purchase an adapter that is certified by one or several of the companies that are qualified to give IEC power supply safety certifications. More about these safety standards are discussed in Section 4.3.

One thing to note, the 24VDC input was an assumption made early on when we were not certain what devices we would be using and what power requirements they would need. This value is subject to change in the future if we discover there is no need for 24V, but as of now we will be assuming a 24VDC input for our entire PCB.

These adapters have a male circular DC connector that has a 5.5mm outer diameter contact, and 2.5mm inner diameter contact, and is 10mm long. Thus, we need an appropriately sized female connector on our PCB that matches these same measurements, and preferably a through-hole component to ensure it is solidly in place so we won't have input voltage issues.

5.5.1.11.2 Mini-USB Connector

A mini-USB connector is necessary to connect our computer with our interface to the STM32 microcontroller development board. The cable is needed to program the board, power the board, and communicate with our computer over UART communication protocol. Since the mini-USB is not actually connected to our PCB, we do not have to worry about a connector component on our board the same way we do with the AC/DC adapter. Still, considering the mini-USB is part of the microcontrollers function, and the microcontrollers output signals are very strongly tied to our PCB design, we felt it necessary to discuss here.

5.6 Software Design

5.6.1 MCU Firmware

Because the firmware will be interfacing with an external computer through a UART connection, the main program control will come from commands. Before receiving any commands, the firmware will first initialize the necessary hardware. This includes tasks such as zeroing out stepper motor axis, ensuring the laser is safely off, and ensuring sensors have been turned on. Once a command has been received, the firmware will branch to the correct respective function. Control of the hardware components like stepper motors and the laser controller will also be handled through functions. This way the firmware is modular, and refinement of a particular process for the system will be relatively easy. The general processes of the firmware will be:

- Begin printing process
- Stop printing process
- Resume printing process
- Interface with external CLI

- Show diagnostic data
- Indicate status of SD contents
- Change parameters

The following sections will describe the different components and their design. A flowchart showing the general functions and components that will be implemented is shown in figure 30 below

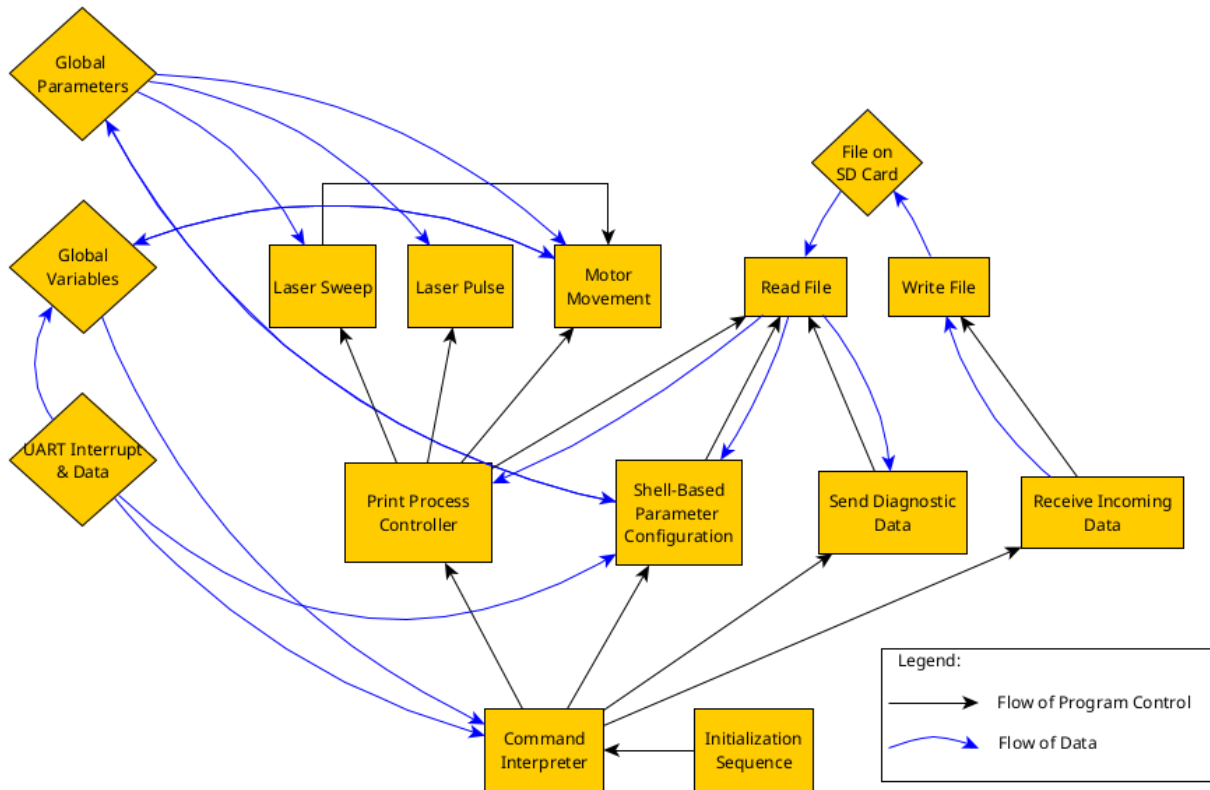

Figure 30; Flowchart of general firmware components and program flow

5.6.1.1 Initialization

Before the system can begin operating, the microcontroller must know that all subsystems are working correctly, or in the correct state. The components that need to be checked once the system has been turned on are the stepper motors, the laser head, all sensors, and the SD card.

For the stepper motors, we must check that they are in their zeroed position. This way, the printing process will always start at the same position, reducing troubleshooting or alignment errors. To check this, we can place tactile switches along the control axis at the desired position (zero could be any corner). If the switch is not toggled during initialization, then the stepper motors will move backwards on their respective axis until the switch position has been struck.

When the system is turned on, the laser head needs to be turned off to ensure that a laser beam does not begin being generated. Initialization for this subsystem will likely look like cutting power to the laser head and ensuring that no PWM signal is

generated yet. This part of initialization needs to take place first, considering that the laser is the most dangerous part of the system.

Initializing sensors will be specific to whichever models and sensors are chosen to be used. Some sensors come with controllers on the same circuit, and have specific inputs needed before they can be used. Some sensors simply need to be powered on and they begin outputting data. If the sensors chosen to be used in this project are of the later type, initialization will mean checking that some form of data is being sent to the MCU, indicating that the sensor was able to successfully turn on. If the sensors chosen are of the former type, then initialization will entail conforming to whatever procedure the sensor outlines in its data sheet.

Initializing the SD card is simply checking whether or not a card is inserted into the system. Because the printing process draws data directly from whatever file is stored, if an SD card is not present nothing will happen. Whether an SD card is inserted can be checked via a card detect switch built in to the SD card slot. If the card is not present, the system needs to not go into normal operation and let the user know of the error.

5.6.1.2 Printing Process

The printing process will be relatively simple, as the file stored on the SD card will be a bitmap where each 1 corresponds to an arbitrary pixel (or 'dot') on the paper that needs to be engraved. Each line will include an index number, which will help the firmware know where the system needs to be on the Y axis. Essentially, the microcontroller will process the printing file stored on the SD card line by line, character by character. With predefined global parameters such as the paper size and number of pixels, the movement of the stepper motors to go from pixel to pixel can be calculated at initialization. The printing process as a whole can be seen in figure 31.

One downside to this process is that the laser head will be turned on and off rapidly, even if all pixels in a line need to be engraved. This can be damaging to the laser and needs to be minimized if possible. A possible optimization is to look ahead whenever a 1 is encountered in the line. Then, we can index the length of the segment and move the character pointer to the 0 following. It then becomes possible to instruct the laser to engrave in a continuous horizontal line, while still scanning the file character by character.

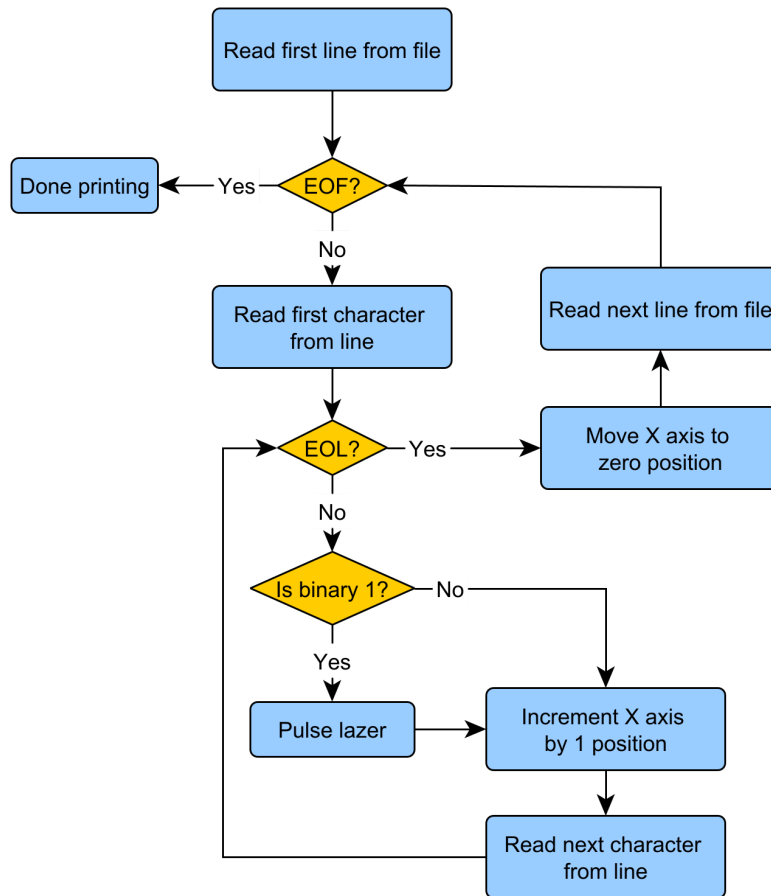

Figure 31; Printing process in MCU firmware

5.6.1.2.1 Controlling the Laser

In the section above, it can be noted that generating reliable and accurate laser pulses to engrave each 'pixel' on the paper is a vital part of the print process. The laser head should already be in the correct position before it even needs to be turned on, so when the beam turns on is not important. What is important is generating the same laser beam for the same duration every time.

The laser that we have chosen has two inputs, a power line and a PWM signal. Adjusting either of these changes the beam strength, and extensive testing is needed to find the correct settings to engrave a piece of paper without burning through. To control the power via the microcontroller, we can introduce a MOSFET to the power line so that it can be toggled with a GPIO pin. The specific voltage and amperage acquired through testing can then be a constant via a supply circuit. Control of the PWM signal can be handled with the microcontroller's timer modules.

Within the firmware, the laser's specific parameters to engrave the paper to the right specifications can be stored as hard-coded global parameters. Then, a pulse function can be used to faithfully replicate turning the laser on and off according to these parameters. This will ensure that a replicable dot can be achieved each time.

If it is desired to engrave sweeping lines, specific functions can be written to pair turning the laser on with a specific motor movement. The speed of the motor and the intensity of the laser will have to be fine tuned together, so that the laser does not sit on one spot for too long or too little. Similar to the pulse function, this can also be governed by hard-coded global parameters that are determined through experimentation.

5.6.1.2.2 Controlling the Stepper Motors

The firmware will not be interacting directly with the stepper motor. Instead, it only needs to know how to communicate with the stepper motor controller. The controller that we have chosen for now is the Allegro A4988 stepper motor controller. This controller accepts a PWM step signal and a direction signal. By controlling these two pins, the microcontroller can tell the motor controller how many steps the motor needs to move, and in which direction. The motor controller also has three pins that allow the user to define which 'microstepping mode' the motor should be driven in. This means that the controller can increment the motor by anything from full steps to sixteenth steps.

Considering that driving the motor will be very easy for the microcontroller to do, we're interested in constantly knowing 'where' the motor is. Without this knowledge, accurate control of the print axis will be nearly impossible. Knowing the stepper motor's step angle, and the gears used on the axis that the stepper motor is mounted on, we can calculate how far along the axis one step of the motor correlates to. Knowing this, we can map the axis from 0 to the max value. These can be stored as hard-coded global parameters within the firmware.

To have positional control over the axis that the stepper motors control, we need to know where the motor currently is. This could be done with sensors, or it could be done by keeping track of where the motor was moved to last. Because stepper motors have a high level of accuracy and repetition, we will code the firmware following the later approach. With a global variable keeping track of the motor's current position, a function can be written that will move the motor to location X on the axis. Using the current position of the motor according to the global variable, the function can calculate how many steps it must take and what direction. It can then drive that many cycles of a PWM signal to the respective output pin and update the global variable to its new position.

With this design approach in the firmware, it becomes possible to switch out the stepper motor models very easily if need be. All that will be needed to change will be the global parameters that map the motor's steps to its control axis, which can easily be calculated by hand.

5.6.1.3 UART Interface

Most data and commands will be coming from the external computer via a UART serial connection. This means that the firmware needs to be ready to receive UART communications at all times. This can be set up through hardware interrupts in the microcontroller, which will signal that a new data has been received and is ready to be

read. The interrupt does not need to be used to make use of UART communication, as polling methods are also possible.

Once a word has been received on the UART channel, the interrupt can allow the firmware to update a global variable and indicator flags. This way, the program can have ready access to the latest command. This will allow for features such as stopping the print process midway. It also ensures that the firmware can still run in its critical sections without having to process new input. If it is not necessary to accept a new command, the code won't check the global variable for new input. This approach will primarily be used when pulsing the laser, or moving the stepper motors. An interrupt mid-pulse is not likely to cause issues, because it will simply update a variable. However it would be a major safety concern if an interrupt caused a new command to be processed while the laser is still on.

5.6.2 Document Processing Software

To optimize the data sent to the microcontroller, the document processing software is going to be written from scratch. The image processing itself, however, does not need to be re-invented. The open source OpenCV library supports a plethora of programming languages, and makes it very easy to open different types of images and directly interact with their pixel data. This is because the library stores all images as a matrix of pixels. Our desired output is an uncompressed bitmap with no depth, so this is perfect. Essentially, we just need to use the OpenCV library to convert our images into a desired black and white image.

OpenCV's built-in functions already handle a majority of the processing that we need to accomplish, reducing the amount of code to a few lines. Once our input has been read into a matrix, we simply resize to a destination matrix. We then convert the image to grayscale with a conversion code. To then convert the image to black and white, we apply a threshold to the pixels. Depending on the threshold used, the pixels will either be zeroed or maxed out.

After testing this functionality, it became apparent that using the same threshold for black and white conversion across an entire image poses issues. The text in an image becomes legible at a different threshold than the image does, and often both cannot be seen clearly at the same threshold value. It then becomes a necessity to be able to process different regions of the image with different thresholds. To illustrate this problem, see figure 32 below. The processes of applying different black and white thresholds to different areas of the image will be referred to as using selective thresholds.

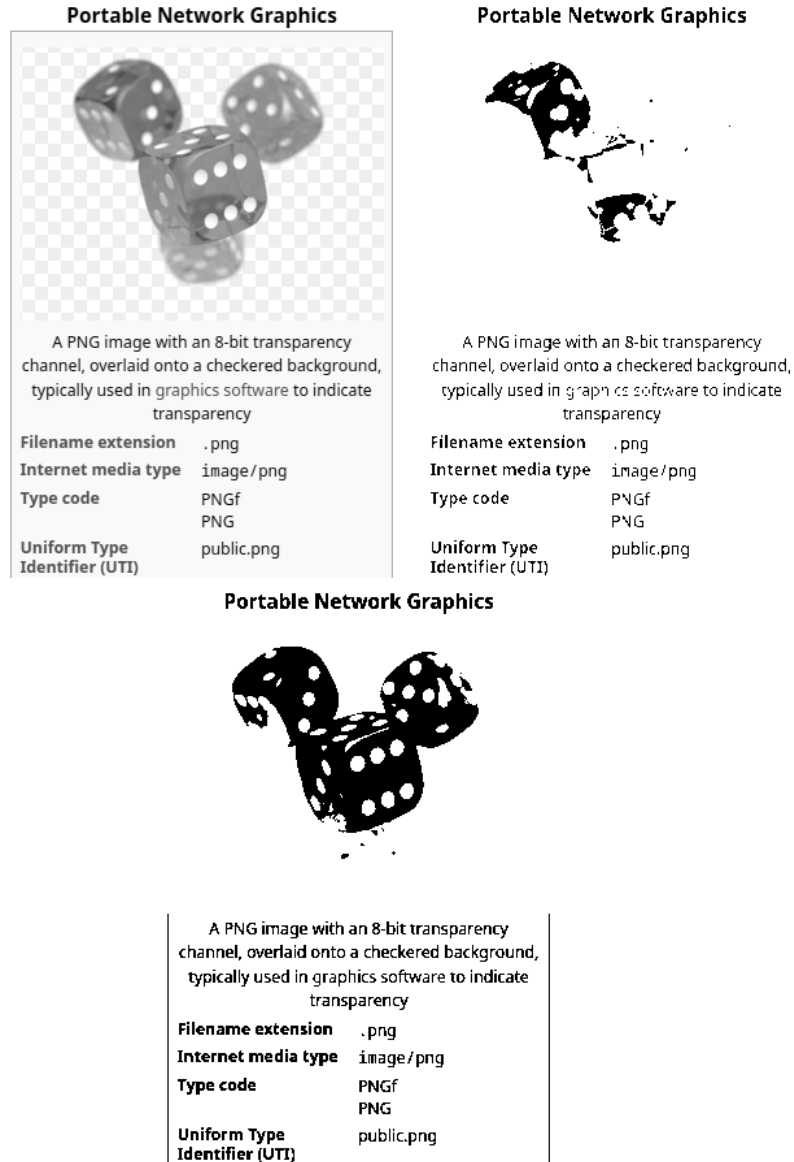

Figure 32; Original grayscale image compared with conversion using global threshold and selective thresholds, respectively

Because it is unrealistic to expect our user to define these selective thresholds within code and recompile for every new image, a GUI will be designed so that the process is as simple as drawing a rectangular area over the input image in a display. The threshold will be changed with a slider, so that the effects of different values can be seen in real time. Using this approach, it becomes possible to apply default values to documents and quickly print, while also allowing the option for better print quality if desired.

5.6.1 GUI

The GUI for the document processing software is going to be the main point of interface for the system. It will not have too many options so as to confuse the user, but

will simply be a visual environment for setting up your image before printing and for interacting with the system's UART interface. With these goals in mind, the GUI will be broken into three spaces:

- Image viewing window
- Image and Filter options
- UART terminal

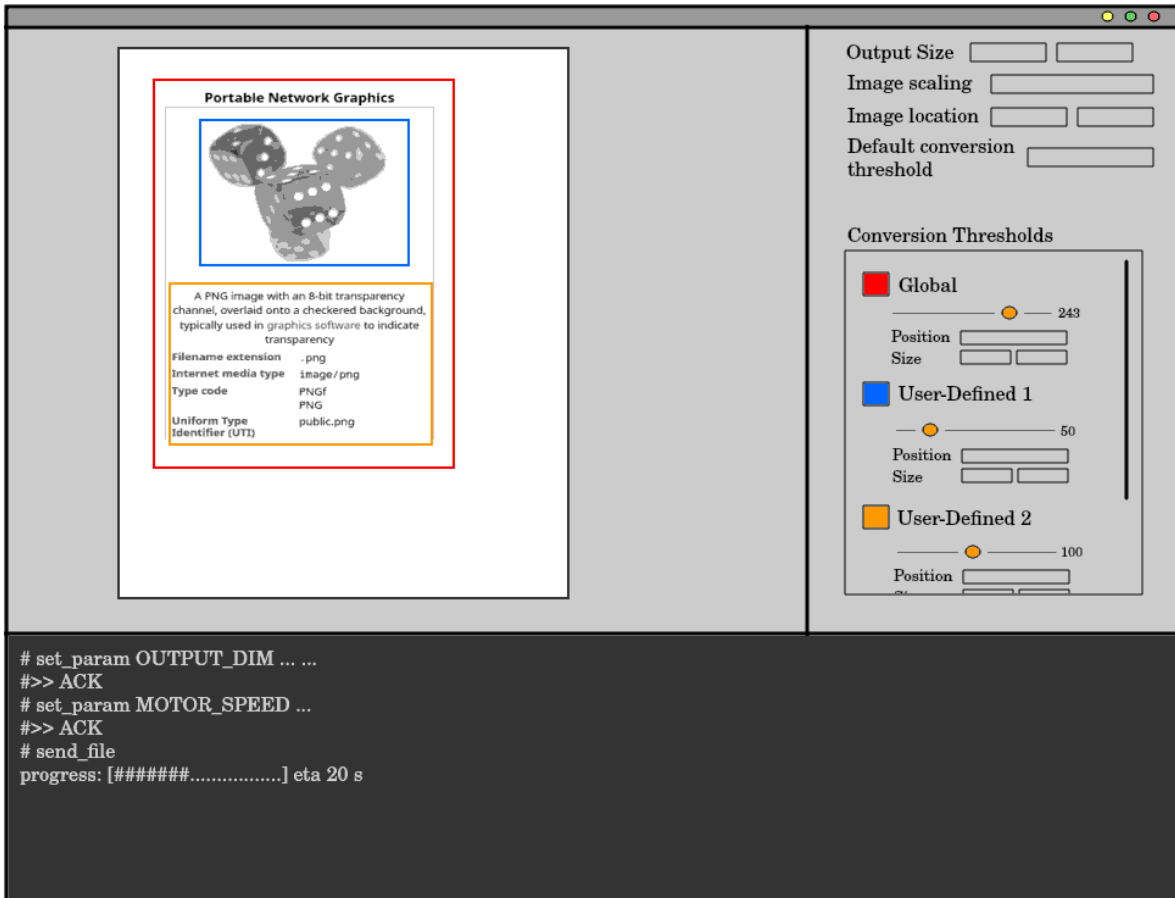

Figure 33; GUI rendering

The Image viewing window will primarily be empty until an image has been loaded into the program. Once an image has been loaded, it will be displayed over a projection of the output 'pixel space' of the paper that the system will engrave on. The size of the output space will be adjustable in the options window, but will default to the size of a sheet of A4 printer paper (as defined in the requirements for the system). The user will be able to resize their image or move it around on the output space to determine where on the paper they want it printed. When the image is converted to black and white, the user will be able to define the threshold for conversion and create any selective threshold areas that they desire. These areas will be viewable in the viewing area to make the process of refining the image as easy as possible.

The image and filter options window area will be to the side of the image viewing area, and will show the user all parameters being used for the image. These will include things like output size, image scaling factor and location, global conversion threshold, etc. There will also be a list of the user-defined selective threshold areas that have been created. By keeping track of the areas like a file tree, the user has more input to see what exactly they're doing. An implied feature of using a list like this is that the user would then be able to define which areas precede others, and overlap. All selective threshold values in the image and filter options window will have a slider to adjust their value, so that it is possible for the user to estimate their desired value.

The most important feature of the GUI will be the UART terminal. This window at the bottom of the GUI will display any and all communication to the microcontroller, allowing the user to view and diagnose any problems that may occur. Through this window, the user will be able to communicate with the microcontroller as if they're interfacing with a simple shell environment. There will not be many supported commands, which will make user interaction even easier. When a parameter that the firmware needs to know is changed by the user via the GUI (such as the output dimensions), the program will handle sending the appropriate commands to update this parameter over UART. These communications will be shown in the terminal, which will allow the user to see that the parameters have been successfully updated.

5.7 Frame and Axis Control

Throughout this section we will discuss the design that we have decided to go with for the mechanical design of this project. It should be noted that currently we still plan to do the mechanical design ourselves. If we run into time constraints we will have to buy a mechanical XYZ stage to solve this issue. This will most likely be a 3D printer rail system. This will make programming the system easier as well since there will already be software that is similar. Many aspects of this section will refer back to section 3.7 where we discuss basic research behind this mechanical system.

5.7.1 XY-Axis Gantry system

The gantry system is a very important aspect of our project. This is because this system will hold our laser and will be vital for our project to work and function as intended. If the implementation of the gantry system is not up built accurately enough, then positional accuracy errors will be inherent in all operations, and the system will be incapable of producing engravings that are up to specifications. To maintain the positional accuracy required to meet specifications, and to be able to move the laser head at maximal speeds, we've decided to implement a Core-XY belt configuration gantry system. The details of how the configuration works can be seen in section 3.7.4.4.

The corners of the gantry system will be 3d printed, and will match the size of the stepper motors when mounted so that the motor shaft is vertical. Two corners will be designed so as to mount the stepper motors, and two corners will be designed with two

pulley mounts along the 45 degree line dividing the corner piece itself. The pulleys, gears, and timing belts will match the configuration shown in figure 14 within section 3.7.4.4. Guide rods will be glued or clamped into holes within the 3d printed corner pieces, whichever is more viable for the quality of 3d print that we are able to achieve using printers within the senior design lab. The multiple mounting apparatuses that will be sliding along the guide rods will be 3d printed as well, and will fit a linear bearing that is the same size as the guide rods. Similar to the guide rods within the corner pieces, the linear bearings will either be glued or clamped into the 3d printed mounting apparatuses.

The gantry system will be designed in a way that it is independent from the rest of the frame. Ideally construction will be high enough quality that it is able to remain rigid without additional frame support, and can simply be connected via the 3d printed corner pieces. This connection will most likely be done with aluminum rails. The connection could also be done by extruding the 3d printed corner pieces downwards, and using them as the corner pieces for the bottom frame as well. This method might be desirable to lower cost and increase frame rigidity. By separating the gantry design from the rest of the frame, we make it possible for more modular testing during the construction phase of the project. However, the gantry system will be securely connected to the rest of the frame for final construction, and is not being designed as an interchangeable module.

5.7.2 Z Direction Movement

The next movement system that we need to consider is the z directional movement. This is important for making the laser focus to the correct point on the material. Having a z direction movement system is important for achieving our stretch goal of being able to print on multiple different types of materials. For us to achieve this we are planning on creating a way to move the printing plate up and down. This should be relatively simple. Originally we were planning to move the laser up and down. However, initial research on this design showed that it would be difficult to achieve. This is mainly due to the fact that we were looking to move the entire laser system up and down. However, deciding that we will only move the print plate up and down 1 inch max makes it simpler. It should be noted that if we had more time and budget we would move the laser up and down instead of the print bed.

For this system to work we will design a print bed below the xy movement system to move the print bed up and down ~3/4ths of an inch. This would allow the placement and printing onto plywood. The system will have a way to raise each corner and will control all these motors at once. This will allow the print bed to be raised and lowered while staying flat. We plan to use the distance sensor that will be designed to make sure the print is as flat as possible. This sensor will also have control over the z movement of the print bed.

3.7.3 Mechanical Frame Materials

The mechanical frame will be built using aluminum rails. This is due to how sturdy aluminum is as well as how lightweight it is. From here we plan to use 3D printed corners to save on price. If the 3D printed parts do not work and we run into issues with mounting the rails we plan to switch over to aluminum corners. This will help with the sturdiness of the system as the aluminum parts will have a higher part quality. These aluminum rails will be used for moving in the XY axis.

From here we plan to use a separate system to move the print plate up and down in the Z direction. The current plan for this system will be controlled by having a movement rail on each corner of the print plate. This will be beneficial if there were to be a slightly uneven print we could adjust one side or corner of the print to make sure we don't lose any resolution within the print. We also only plan to move the print plate up and down ~3/4ths of an inch. This is mainly a budgetary constraint. Ideally we would like to be able to support more than just materials that are 3/4ths of an inch thick however, designing a system for this will be significantly more expensive.

We are planning to use wood as a print bed. This is mainly due to the fact that initial testing within our system shows we can print onto wood however, it should not be possible for us to start a fire on the wood. This makes it a great material that is flat, relatively cheap and not highly reflective. The reflectivity of the print bed is a big concern due to the fact that we do not want the user or anyone around it to be hit with a stray beam.

6. Integration and Testing Plan

6.1 Hardware Test Environment

The hardware test environment will consist of breadboard circuits in combination with a multitude of meters and scopes. This will be done within the Senior Design lab, where digital multimeters and oscilloscopes are readily available.

6.2 Hardware Specific Testing

6.2.1 Stepper/Servo Motor Test

Before even attempting to assemble the CNC-type machine that will become our laser printer, we need to be certain the motor of our choice will be able to behave and move the way we need it to. When we first get the required parts, we need to use simple programs on the microcontroller to test our motors. This does not necessarily have to be our own program made from scratch, as plenty of programs for popular microcontrollers already exist for simple stepper or servo motor movement.

With a servo, we can use the microcontroller to send PWM signals that allow us to control the position and movement. Microcontrollers also typically feature

Analog-to-Digital converters. A simple breadboard and jumper cables can complete a set-up for testing the motors. Using a potentiometer, we can input an analog signal into the microcontroller, have the controller convert it to digital values, and use those digital values to control the duty cycle of the PWM signal. With the potentiometer, we have created a knob that can control the position of the motor.

If we are satisfied with its function, we can assemble the motors onto the rails they are expected to be on and continue using the potentiometer set up to move the device around. We can observe the range of motion of the motors and doing so will help us adjust numbers in our program until we can achieve precision, range, and speed that we are satisfied with.

Once these basic tests are complete with the motors, we can then begin attaching the laser to the device and see how it plays out.

6.2.2 PCB and Power Supply Testing

The main master PCB we have planned for the project is going to be responsible for powering the majority of all the components in our project. There is no denying that we are using components that we likely do not want to have to buy again, so extensive testing is needed to ensure that our PCB design delivers the correct power to every component and won't damage anything, especially the more expensive components like the laser diode.

6.2.2.1 AC Power Adapter

Our main PCB will be connected to an AC power adapter that can plug into any 120VAC, standard U.S. wall outlet. It has been undecided what DC output this adapter will need to be, but we estimate somewhere in the 15VDC-25VDC range. This can be changed if needed by simply purchasing a new adapter as they are relatively inexpensive. Referring to the IEC power supply standards discussed in Section 4.3, we want to certainly buy an adapter that meets these standards. The best way to do this is checking for the certification badges on the product itself, given by several different companies whose job is to certify these products.

6.2.2.2 General PCB Probing and Testing

When we have a fully assembled PCB design in our hands, before we plug in any components we must go through extensive testing of the design. We need to plug it into the wall adapter and use a multimeter and an oscilloscope, provided by the Senior Design lab, to ensure that the measurements we are reading are the ones intended (by comparing it to our ideal LTspice simulated circuit).

Multimeters can help us ensure that the DC voltages we want to be connected to our components are the correct values, and oscilloscopes can allow us to get a closer

look at the signals themselves to make sure they are behaving as intended. One worry is the threat of voltage spikes, something that can occur especially at the moment of plugging in the device or unplugging it. The oscilloscope will be able to help us identify any dangerous voltage spikes in these scenarios, and then we can make design choices and edits such as adding capacitors or flyback diodes to neutralize these voltage spikes. Extensive probing and testing of the PCB will help us be confident that we won't accidentally destroy a sensitive component of our board once the assembly of the final product is complete.

6.2.2.3 Voltage Regulator Testing

Before fully designing our PCB, we needed to make breadboard circuits and prototypes of our intended voltage regulators. This will help us decide what components are the right choice, and to verify if our schematic and simulations of voltage regulators are correct.

6.2.2.3.1 LM317 12V Prototype

The LM317 is an adjustable linear regulator, and for prototyping purposes we re-created the 12V regulator from Section on a solderable breadboard. Due to availability of parts, we could not get the exact same capacitor values, but this regulator was designed with a 24V input and a 12V output in mind either way.

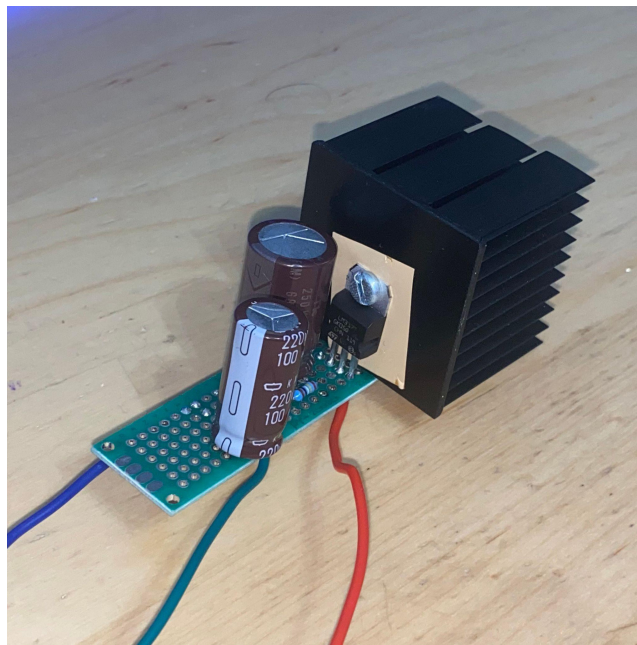

Figure 34; LM317 Adjustable Regulator prototype with 12V output

With the red wire and blue wire as input voltage and ground respectively, and the green wire as output, we could test to see how well it worked. The output was stable at

12.5V with no load. To push the regulator to its limit, we attached a 36Ohm power resistor load to the output to get an output current draw of around 350mA. This resulted in the LM317 regulator chip getting very hot and dropping voltage significantly as a result of too much heat. Originally, the prototype board did not have a heat sink as shown in the image. After attaching the heat sink to the LM317 and a thermal pad to protect it from any accidental shorts, we attempted the 350mA load test again. This time, the regulator could actually maintain stability at around 12.5V while still outputting 350mA, with no noticeable voltage drop.

The LM317 on our board will most definitely not be used to power a high-current device, so a heat sink may not be necessary, but it is good to know that it is an option if any particular regulator is outputting more current than is expected.

6.2.2.3.2 LM2576 12V Prototype

An LM2576 prototype was also created on a solderable breadboard. It was made as closely to the schematic on Section 5.5.1.3.4, with the two changes being a MSB1060 diode instead (although it has very similar characteristics as the MSBR360), and the inductor being 85uH instead of 100uH. Either way, it was still designed to have a 12V output.

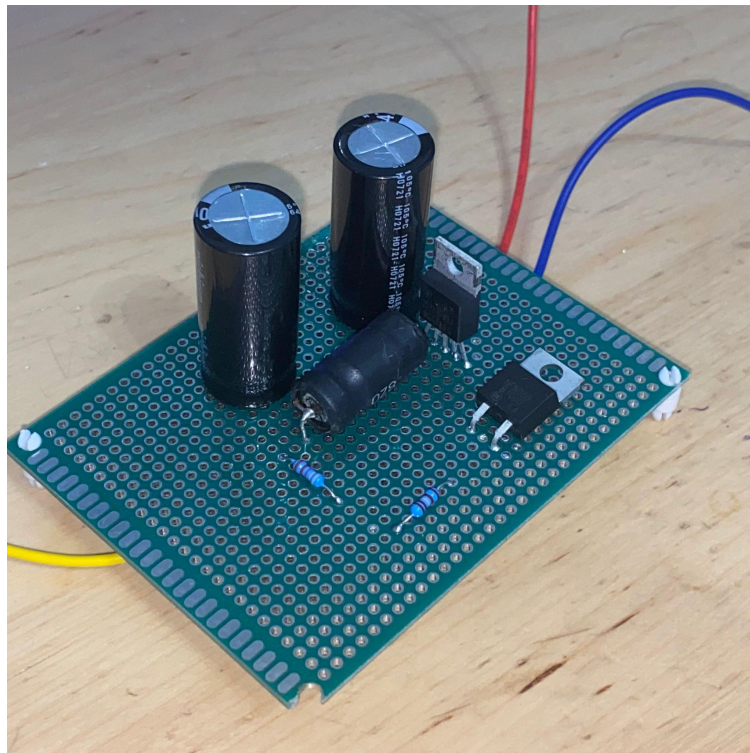

Figure 35; LM2576 Adjustable regulator with 12V output

With the red and blue wire being the 24V input and ground respectively, and the yellow being our output, this prototype board was measured. It was stable at 12.3V with no load. With a 36Ohm power resistor attached to the load, the output current was

about 340-350mA, and the voltage remained stable at 12.3V with no significant voltage drop. Buck regulators do not generate nearly as much heat as linear regulators do, even at high currents, so it was able to maintain a 340mA output without the need of a heat sink unlike the LM317.

Unfortunately, early into testing this board a capacitor was accidentally shorted with an alligator clip and this somehow caused the output to now only regulate at about 10V. Either way, the LM2576 adjustable regulator proved to be effective at high current output and great at not generating heat. This design, although with smaller surface mount components instead, will be seen in our PCB, powering our laser diode driver.

6.3 Laser Test Environment

The laser test environment that was used was inside of the CREOL Senior design lab, this is located on the second floor of CREOL. Throughout this testing there was a lot that was learned about our project. One of the biggest takeaways was that the overall size of our optical setup was way too large and that we would need to really look at other lenses to fix this issue. The other issue we had was that we did not yet have our laser that we had ordered. This is due to the fact we had been really struggling to find a laser diode and controller that could arrive in a timely manner for this demo.

6.3.1 First Laser Demo

During the building of the optical setup we ended up using a green HeNe laser that has a wavelength of 532 nm. This definitely caused some issues because we had designed our entire demo around using a violet laser at 405 nm. At the time we had an order placed for a 450 nm blue laser diode and controller. However, the lead time on this laser diode and controller was roughly 22 days. This meant for the first demo we would not have our laser diode and controller. This meant being able to prove that we are going to be able to physically burn the paper was very difficult.

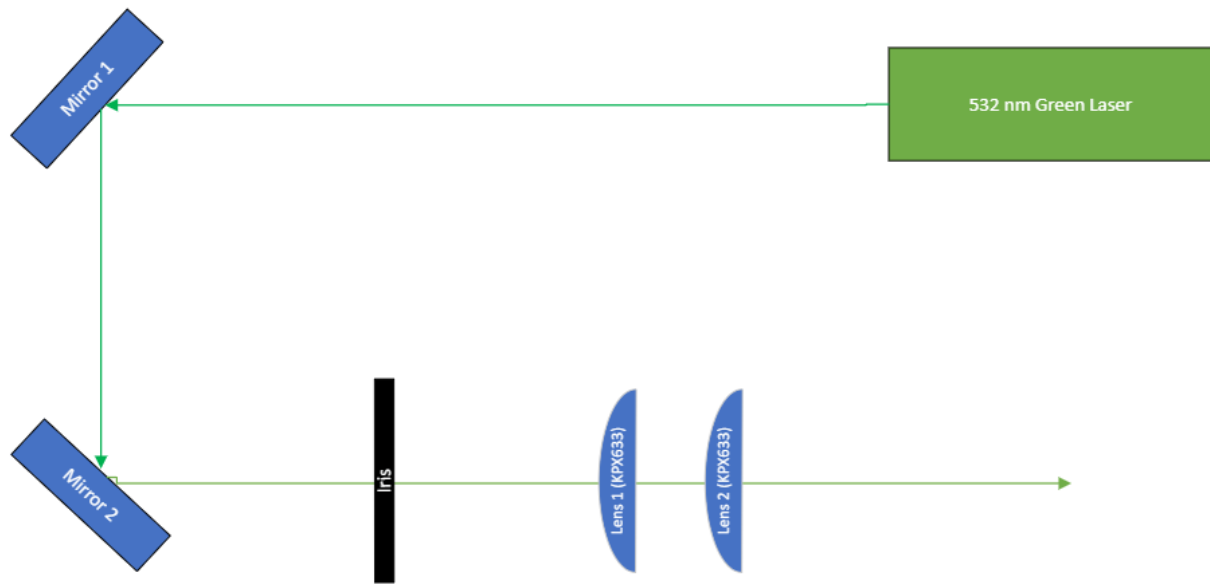

Figure 36; Schematic of the laser setup for the first demo

The figure above shows the optical setup that was used for the first laser demo. This optical setup required an iris due to the fact that there were back reflections coming off of the lenses that were causing issues.

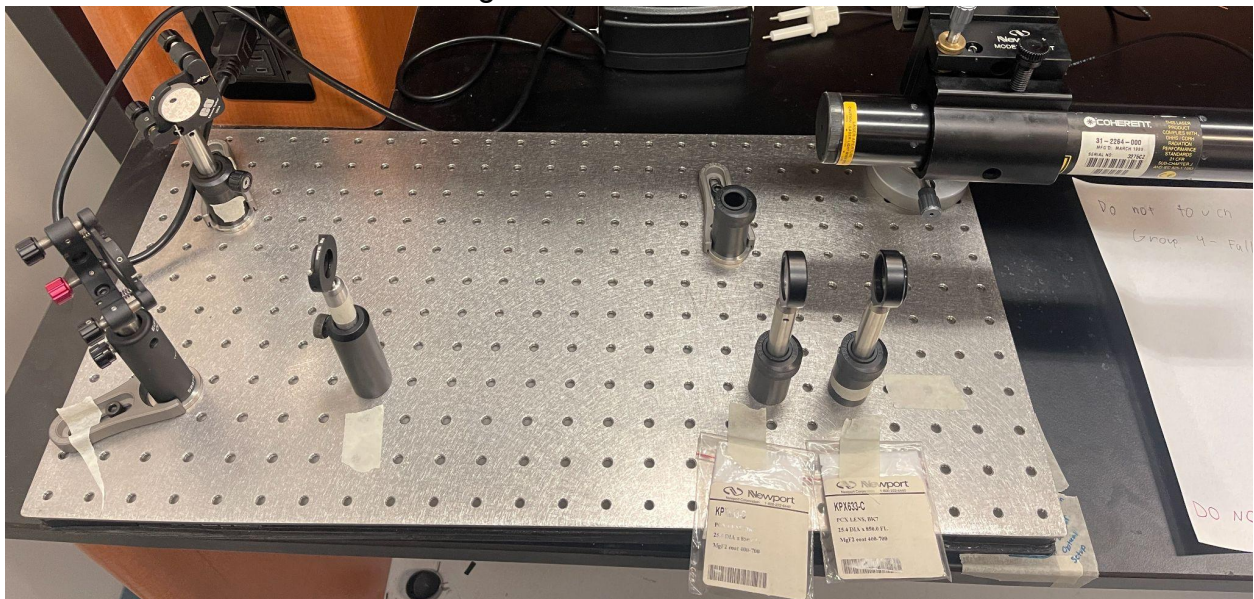

Figure 37; Laser setup that was used for the first demo

The figure above shows the laser setup we had for the first demo. This consisted of two mirrors, an iris, two lenses and the 532 nm green laser. The main thing that we realized from this demo is how much space we took up building this system and this was one of the first things that we talked about after. We wanted to focus on shrinking the system and making it as compact as possible.

6.3.1.1 Laser Demo Size Issue

Regarding the midterm demo performed in Senior Design 1 for Dr. Kar and Dr. Hagan, the main concerns brought up were that the laser and parts used were not those that would be in the final product, and there was worry about the viability of the project without that proof. We had at the time, and still have, taken steps to fix this issue by ordering parts early, and are now in the testing phase of laser diodes to find one which will suit our needs the best. The lessons learned from the initial demo is to reduce the optical track length down from the initial amount to something more manageable. We had originally an optical path length of about 2 meters, however ideally we want that to be under 0.25m total. As well, we want to be able to resolve a diffraction limited spot size according to our lens design process, so that the imperfect reality of the setup has more margin for error. This was brought up when the output in practice was different from the theoretical output, due to the number of assumptions that come with lens design. As more practice and effort is made, more issues will come up, as well as more solutions.

6.3.1.2 Laser Demo Lens Design

Assuming the laser to be a 450nm point source, which at the time of doing the Zemax design was the wavelength that we were planning to use. We can use Zemax OpticStudio to design the lens system for the laser to focus the laser to a diffraction limited spot size at one point, while also having a larger spot that matches our ideal resolution. Our primary goal for the first phase of design was to design lenses around accessibility, and to use that as an experience to learn what we need to change for subsequent designs.

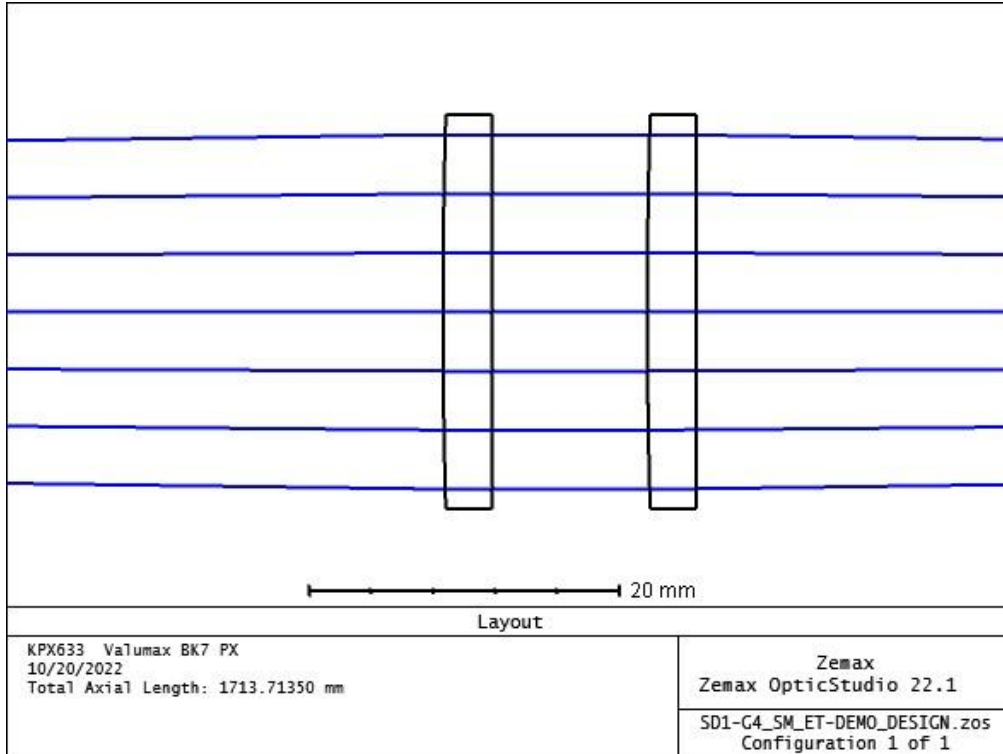

Figure 38; Lens design that Zemax calculated

The design of our cavity was simple and relied on two KPX633 Planoconvex lenses made of BK7 glass. These are cheap and easy to get ahold of, and were good at focusing the light as desired, but the 850mm focal length was egregious, and now the primary goal to change going forward. However, the spot sizes were correct for what we wanted.

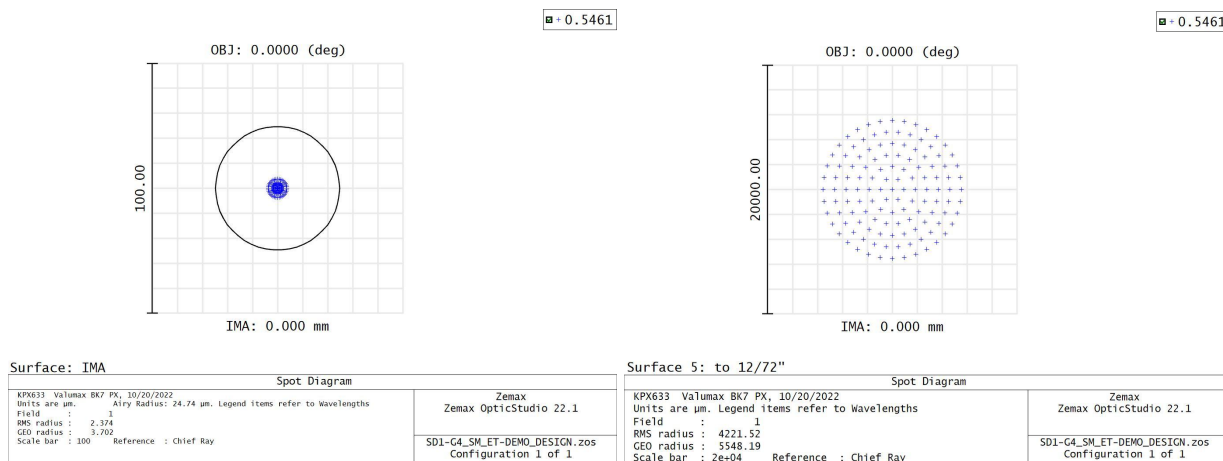

Figure 39; Spot size that Zemax calculated with the an analysis of the results

We were able to easily achieve a diffraction limited spot size, while also achieving a 12/72" spot size in the middle of the track. This is similar to how our system will function later, where we use the work zone as a defocus to bring the image formed by the laser up from the diffraction limited spot to the resolution we've defined for

ourselves. If we want, we could expand the scope of the mechanical design of the project to add a variable table height to increase or decrease the resolution of the laser.

Due to the fact that our optical system also made use of irises to limit the effect of off-axis rays, during the Zemax design, you can see the effect of a purely on-axis system.

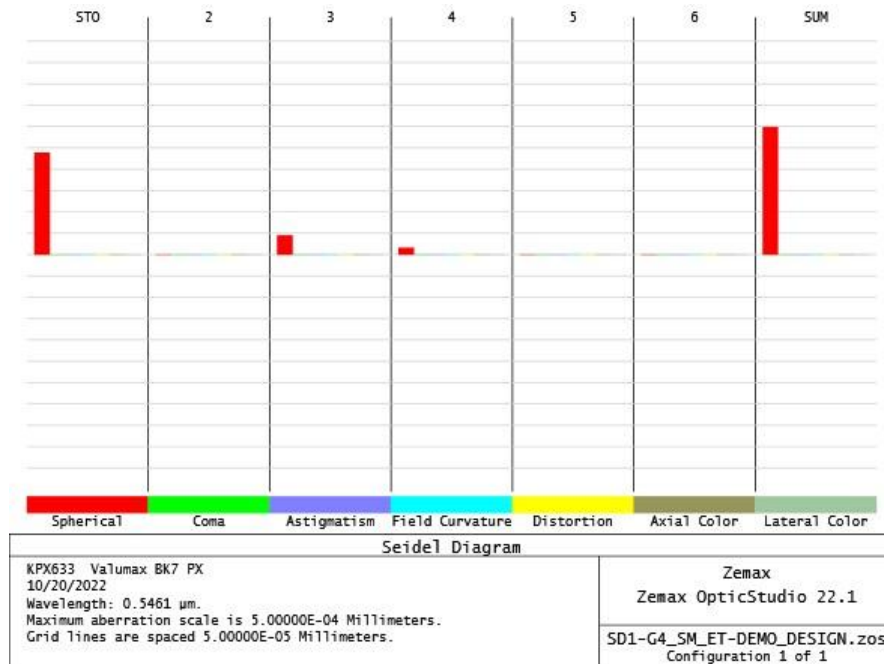

Figure 40; Zemax Seidel Diagram

As seen here, for the third order aberrations, the Seidel aberrations, our system only suffers from spherical aberration. During our designs, we'd like to decrease the level of spherical aberration our system experiences, to ensure better spot sizes, as we will never be able to 1:1 match the Zemax design due to aforementioned assumptions made with regard to the source light.

6.3.2 Final Laser Demo

Throughout this portion we will discuss the second laser demo. At the time of writing we have yet to do the second laser demo.

For this laser demo we had a 405 nm laser diode that we could use to turn on and show the proof of concept that the laser would be able to engrave onto paper, cardstock and wood. We talk about the laser diode that was used in the second laser demo more in section 6.4.3. However, we were able to use the laser to be able to manually write out words onto paper. We were also able to draw images with this laser.

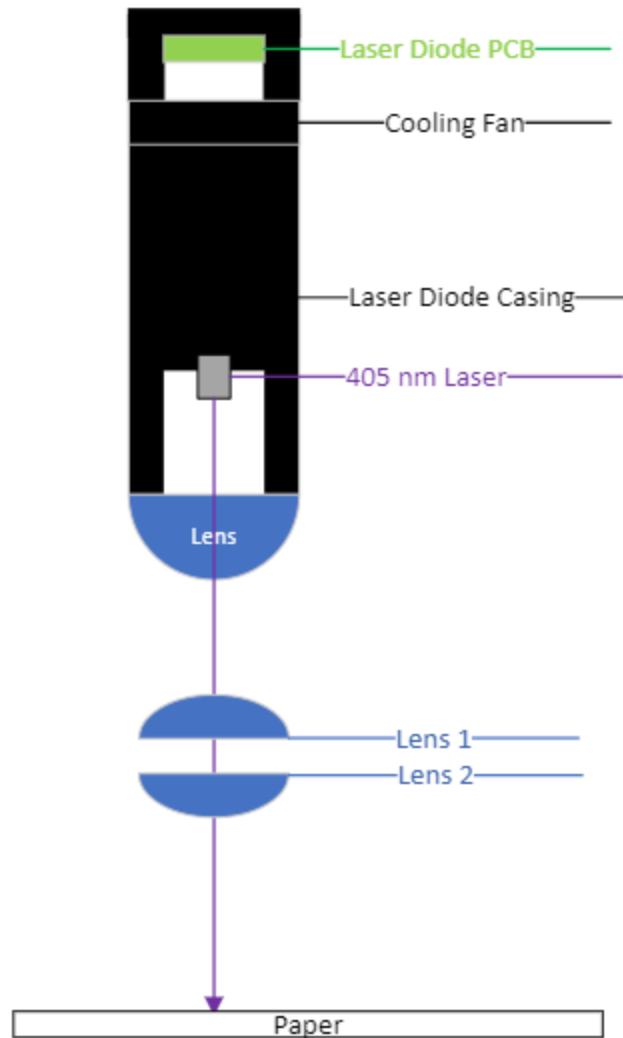

Figure 41; Laser diode controller schematic that was used in the second demo

Looking at the output performance of the laser, we can see a number of things which reflect well on the system. Holding the laser, we were able to write with it onto the paper. This process was finicky due to the unstable nature of handheld operation, but it means that once the laser is properly mounted and operating as part of a rig, it'll have no problem producing the kind of output we're looking for. In addition, the amount of time it takes to produce an output on paper and wood is very quick, resulting in little to no restrictions in place on the speed our motors can operate at, as if the motors move too slowly, we can always reduce the power to the laser to compensate.

Overall, we're satisfied with the second pass on our laser demo, and though we have ambitions to improve upon our results and draft an improved optical setup and begin work on an optical tube lens to reduce potential exposure to the beam, the results are promising enough to shift the majority of our focus onto secondary optical systems.

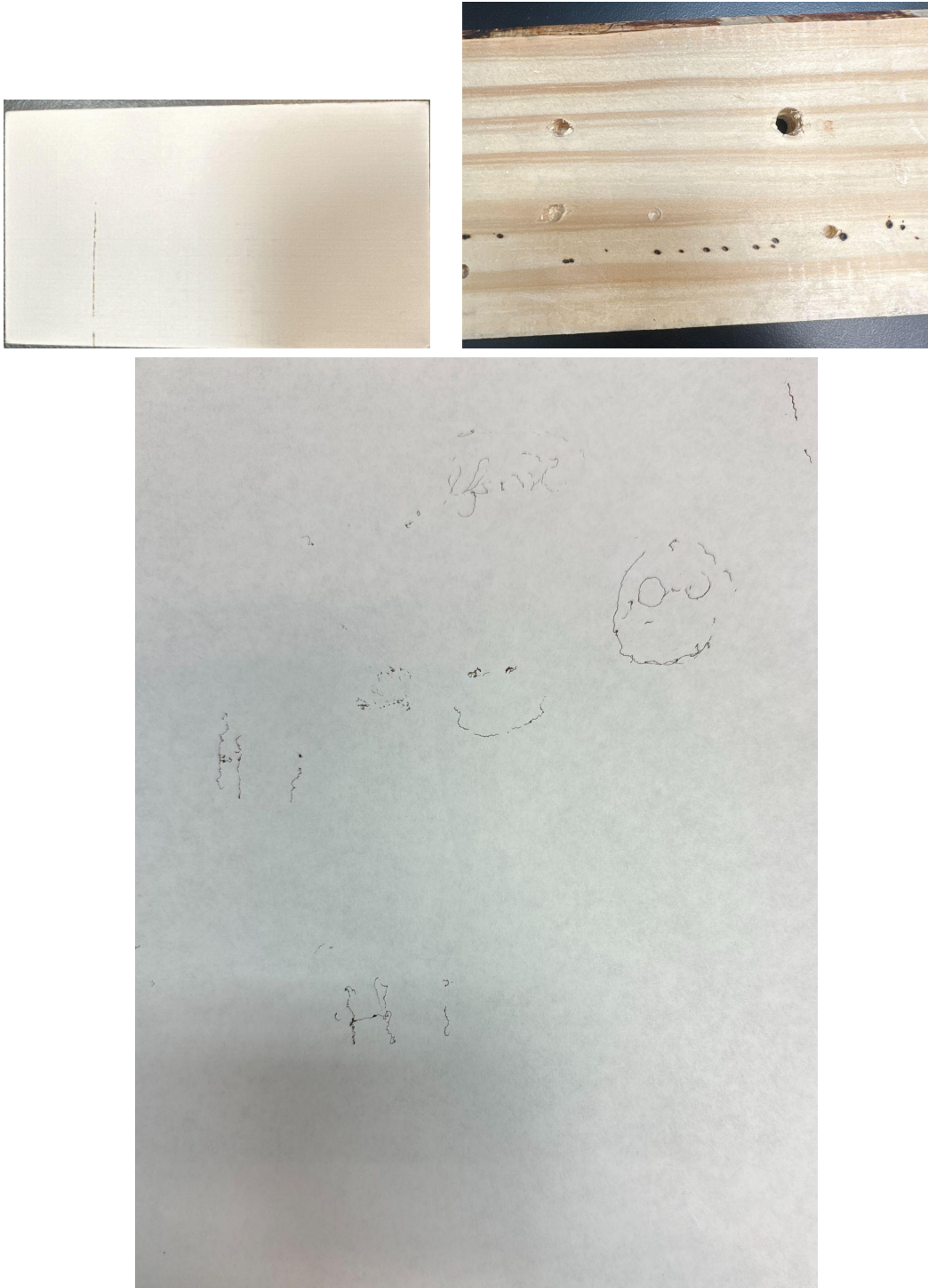

Figure 42; Example Outputs from November 15, 2022

Approximate spot size is $\sim 0.25''$ as of writing using the provided focusing lens, and engraving depth on low-resistance material is $\sim 0.1\text{mm}$. Looking at our outputs critically, the important thing to recognize is the lack of any gradients on the A4 paper, which is desirable as text should show up ideally as a single color. The text is obviously uneven due to the method of writing being rather unorthodox and non-ideal. However,

we also found that writing on something slightly more resilient like a business card was better, as the engraving only occurred on one side, rather than both with the A4 paper. As for the wood, it showed the gradient more pronounced, and shows promise for the level of detail and utility the project could produce.

As for the laser specifications for Zemax design, here is the front face of the laser diode.

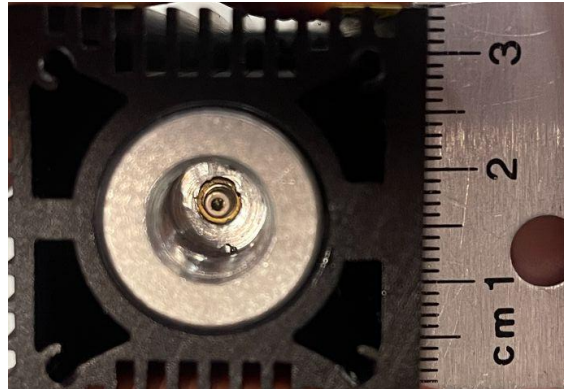

Figure 43; Laser diode diameter

Overall, the Laser as a whole is under 40mm by 40mm, and will likely end up at that specification once a tube lens and mounting system is added to the exterior. The actual laser diode face can be approximate to 5mm in diameter, and this will be used in the Zemax design to plot off axis rays for a better measurement of system aberration. The system also came with a built in focusing lens, which resulted in a focus spot at a reasonable distance. At the moment, we do not plan on using this focusing lens due to the lack of specifications provided on it.

If we now consider off axis rays from 3mm or 5mm out, going over our expected measurement for a sense of security due to the imprecision in the measurement, we can use these in the previous lens design to try and recover the results we were getting within the first demo.

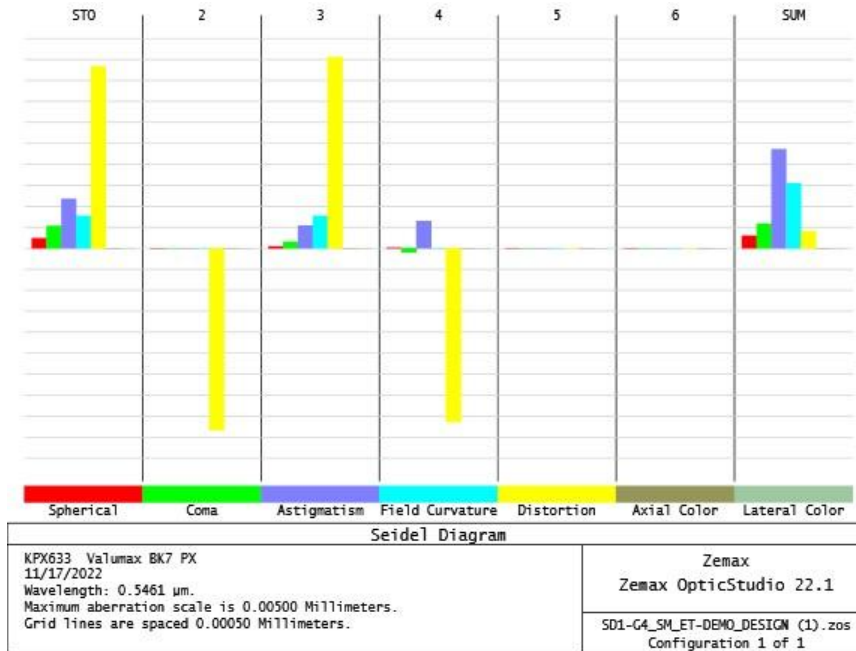

Figure 44; Seidel Diagram for the Second Demo Lens System

What becomes immediately evident by this test is as we expected to see, that the overall aberrations were much worse than expected. Technically speaking, aberrations beyond spherical aberration cannot be measured without considering off-axis rays at all, so now that they are present, we can see what the system suffers from the most. Overall, despite distortion having clear peaks, the system does a good job of actually self-correcting using the surfaces themselves, so distortion becomes much less of a problem than coma and astigmatism, which we noticed in the lab resulted in a “raindrop” pattern. If these aberrations go uncorrected, the optical spot size will deviate from an ideal circle, and struggle to stay within the Airy disc for diffraction limited spot size.

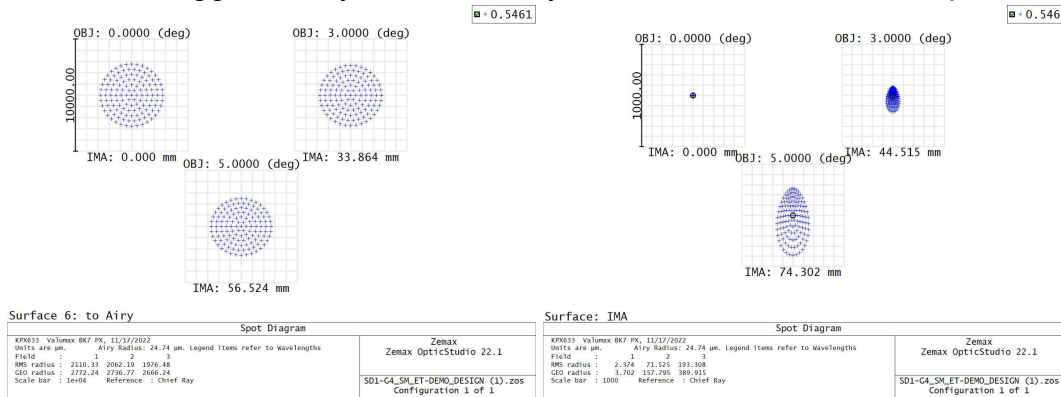

Figure 45; Spot Sizes for Ideal Resolution and Airy for On and Off-Axis Rays

If we look at these images for the spot size, we can see that at the area of ideal focus for our system, the off-axis rays and on-axis rays actually agree on beam shape, meaning that this is indeed the best place for this system to be positioned, however, the 2000+ μm (2mm, 0.08”) radii is not ideal under any circumstance, and would be a heavy limiting factor to our systems resolution. However, getting the spot size radius lower by

going further away also results in the aberration causing more intense errors. These issues all compound on top of the already bad optical track length making the system infeasible, but provide good insight for the optical design of lenses.

Testing with different lenses, including off field rays, we arrive at the following system. Please note that the captions are wrong, and the lenses used here are not KPX633 but rather SPX062.

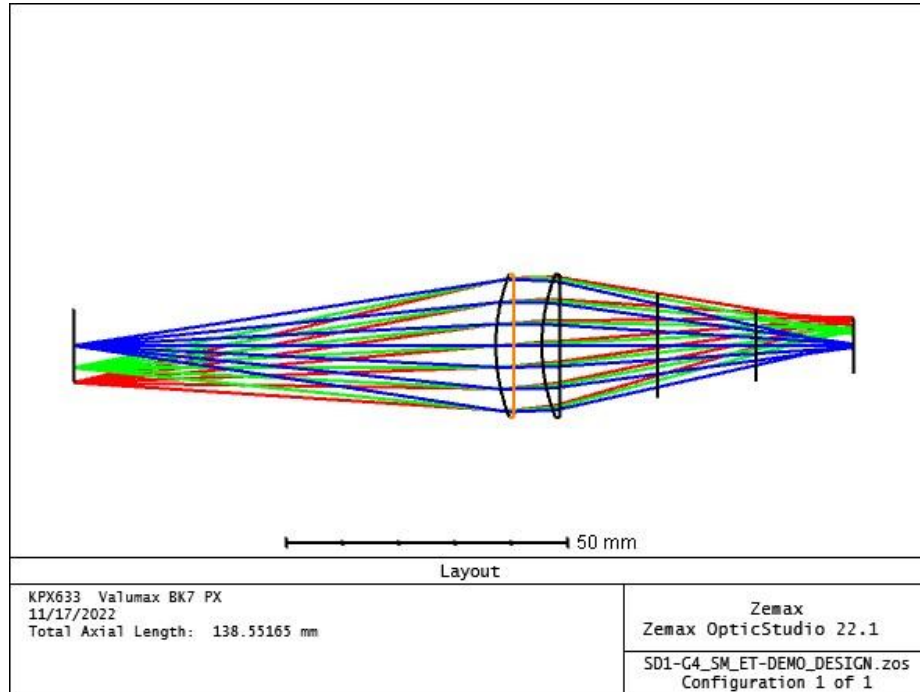

Figure 46; Beam Path for On and Off-Axis Rays for Final System

This becomes a more accurate representation of our system, while also massively cutting down on the path length, down to 138mm from over 1700mm. As for the aberrations present within the system,

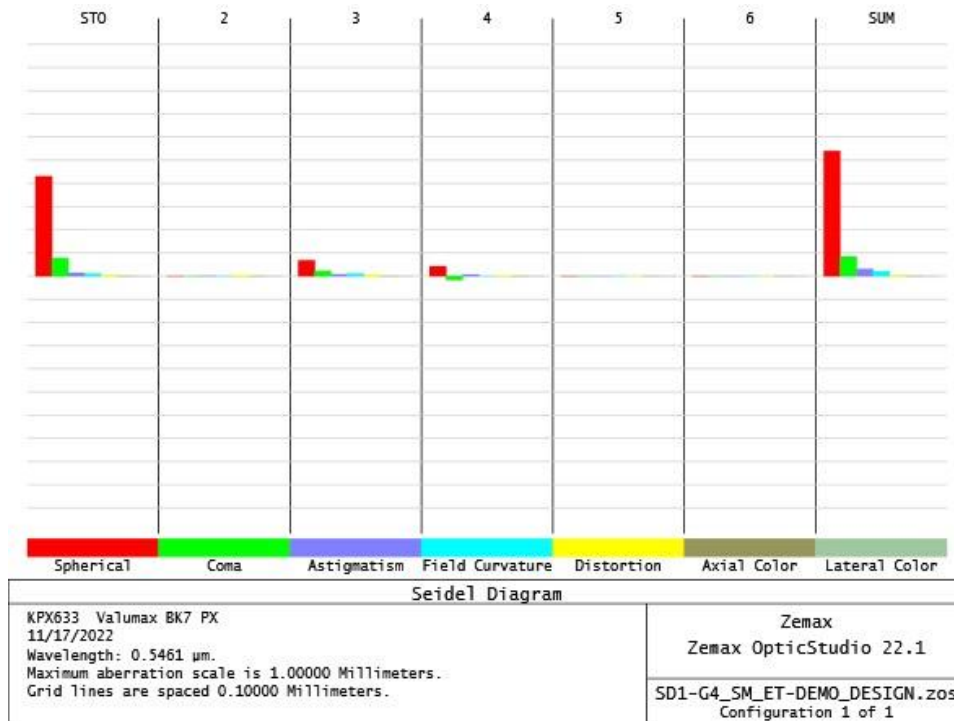

Figure 47; Final Seidel Diagram

Despite off axis rays being considered, the system is almost entirely dominated by spherical aberration. Spherical aberration results in a bloom effect, where the spot size is larger than intended. This can result in a gradient of power being applied to the surface, which is bad for most systems, but not necessarily ours depending on how bad the spot size appears.

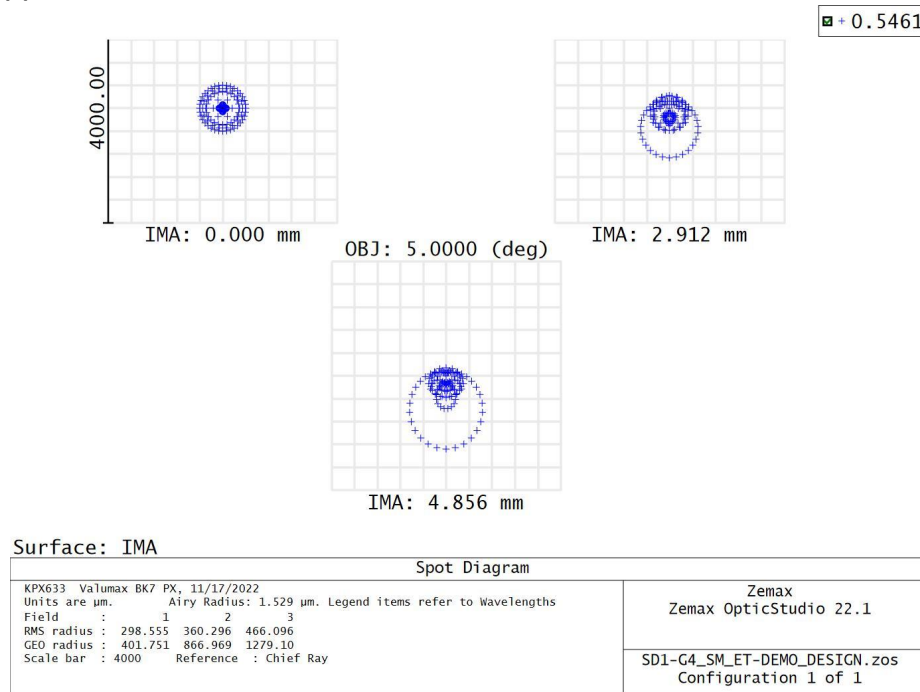

Figure 48; Final Beam Spot Patterns for On and Off-Axis Rays

Looking at the image, we can see the effects of aberration on the 2nd field which is based on a 3mm off axis ray, which should be worse than those we'd get from our laser diode. Still, the size of that spot size is only 60 micron more than the on-axis rays at 360 micron, or 0.36mm, or a 0.03" diameter spot size. This will be well within our tolerances, and the focus spot can be dialed back into a larger spot if need be. Overall, we can use these lenses to achieve a good spot size using readily available lenses that lend themselves well to mounting cheaply, as smaller lenses are a problem for us to mount. Overall, this lens system should vastly improve performance. More searching will be conducted to find and improve upon our lens choices.

6.3.3 Final Laser Demo Results

On December 1st, we had a final demo for the optical setup for our project. Below is a report on our findings and improvements to note for Senior Design II, as well as things learned through the demo that may prove beneficial.

First among the things learned is a greater understanding of the mounting of the laser itself. Our plan is to build or acquire a lens tube that we can mount the laser to, as well as both of its lenses. For our demo, the setup obscured some of the light going into the lenses, and the lack of a specific frame to fit both of our lenses led to a struggle getting the lenses into place. Moreover, when the lenses were in place, their distance to each other was not as variable and controllable as we'd like, and placement left them smudged, which added to the losses of the system. The plan is to, once the lenses and laser are built into the tube lens, increase the length of the tube lens either using the same material, or through a skirt dropped onto the material to completely confine the beam path from view for the purposes of safety.

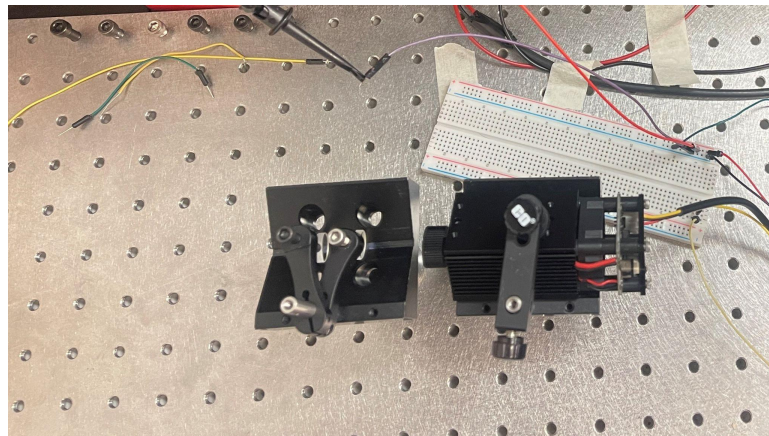

Figure 49; Laser Demo Setup

For our optical setup, we have a preconstructed lens to focus the light of the laser out of the diode and casing into the first of the two lenses. From there, the light is focused to a concentrated spot capable of etching onto paper, with a total optical path length of less than 100mm. Overall, this means that the overall size of the printer can be

vastly decreased, or the lenses can be changed and manipulated to focus later, adding a lot of freedom to the lens design process. The main change that needs to be made for this system are the lenses themselves which have an anti-reflective coating on each side that causes a large detraction of optical power in the wavelength range we operate in. This resulted in us needing to increase the duty cycle of the system, and limit the medium to paper for this demo. However, getting lenses without that coating, or replacing them with slightly different lenses should work. However, aside from difficulties in mounting the lenses, we can either acquire or 3D print mounts for them that'll work well to fix these issues.

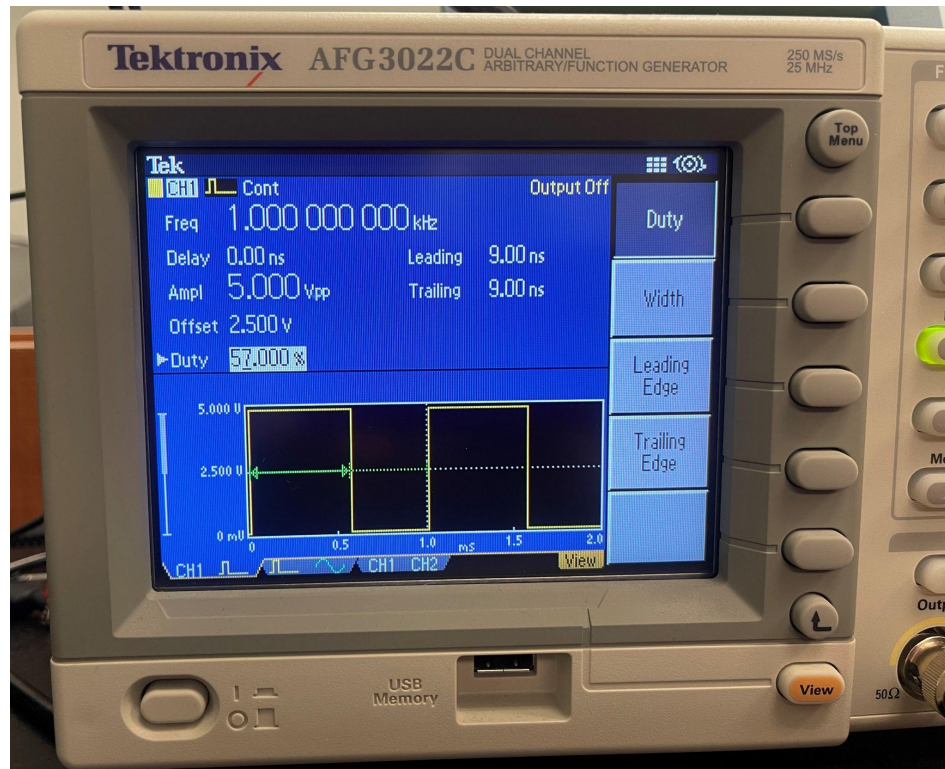

Figure 50; Function Generator Settings

One of the challenges for our project is modulating the laser itself. Direct modulation would involve turning the laser on and off at different points, and though this is possible, the turn-on/off times would lead to a cap on the speed of the printer, and is not worth it. This means that our system makes use of external modulation to stop the laser from etching continuously as the laser moves. Instead, we want to keep the laser on while keeping its power below the threshold for etching onto a material. Then, we can find a way to increase the optical power above that threshold to etch onto material pixel by pixel as we desire. One method we can use to achieve this that worked very well within the demo was using the Duty Cycle on the function generator. At lower values we could stop etching onto paper or wood, but upon increasing the cycle we could start etching. This would provide us the solution we're looking for when it comes to external modulation.

Overall, aside from the improvements to be made listed above, we are content in the state the primary optical component of our project is in. We'll fabricate a mount for

the laser and its lenses to be attached to the mechanical work of the project, and it will work. Other than that, we also would like to create our own specification sheet for the laser system, checking for the optical power at the thresholds between lasing but not etching, etching paper, and etching wood. This will allow us to program the system better, and determine which duty cycles we could adjust to in order to modulate the signal efficiently.

6.4 Laser Specific Testing

Throughout this section we will talk about some of the specific testing that occurred during the semester of senior design I. This will include the purchasing and returning of multiple lasers that we thought would work well but had major flaws. It will also include the issues of working with distributors from other countries and how this played a very big role in attempting to get parts in a timely manner.

6.4.1 Original Laser Pointer

Originally we ordered a basic 450 nm laser pointer off of amazon. This laser pointer claimed to be able to burn paper and looked ideal for our setup. We were planning on deconstructing the laser pointer and using the internals of it to save space on our optical setup. However, after receiving this laser pointer it was unable to burn paper to any degree. The instructions also listed that it should not be left on for more than 5 minutes at a time. This would be a major flaw that we would have needed to overcome if we decided to move forward with this laser. This led us to returning the laser pointer and we started searching for a laser diode and controller. We had chosen this route due to the fact that we knew the previous group used a laser diode controller for their setup. This gave us the confidence that we would be able to find one relatively inexpensively that would fit our needs.

6.4.2 Laser Module

We ordered the laser diode and controller, this was supposed to be a 1.6 W laser module. Due to the fact this was shipping from china the lead time on this product was estimated to be between 15-30 days. It ended up taking about 22 days to show up. This laser module would contain the laser plus a driving board that we would be able to use if we opted to do so. Our plan was to look at the system and decide if we wanted to use the provided PCB from the manufacturer or if we would like to build our own. However, this never ended up becoming a discussion due to the fact that the company ended up shipping us a laser diode and diode controller. The diode that we were shipped was a 4.75 W 455nm laser diode and the controller was a 1W-2W blue laser diode controller. Due to this, questions have been raised about the safety for operating this laser and have decided to look around at other lasers again in an attempt to find something that is less powerful and will still work in our application. With this issue in mind we are

currently in the process of looking at other lasers that we could buy from a more reputable seller that would be able to satisfy the project requirements.

6.4.3 The Second Laser Module

The next laser module we have just ordered and it is coming from amazon. This has helped due to the fact that the lead time on many amazon products are not upwards of 20 days. The laser module would also be only 500mW at 405 nm which from research we have performed may be enough to accomplish the task of engraving onto paper. This laser module also happens to have a manual switch built into the PCB. This is a great safety feature as we are able to turn off the laser using this switch and know for sure that even if power is sent to the laser module it will not turn on and start lasing. However, this should never be a guarantee and regular safety procedures should be taken into consideration when working around this laser module. The laser module does contain a PCB. This PCB requires a voltage, PWM signal and a ground connected to it to be able to operate. This laser module ended up working wonderfully for our project. We started doing basic tests of using the laser to engrave onto wood. We chose this as it was the best beam stop we had available to us and we are also looking at having wood as one of our types of materials we would like to be able to pick from.

As we started doing basic tests of this laser it became very apparent that this laser is overkill for what we are doing. This is due to the fact that the laser can operate at 12 V 5 A DC power. Original testing we were operating this laser at 12 V and ~100mA. Due to this we were able to engrave onto wood while also burning through the paper. From here we decided to work on lowering the PWM modulation that we were using and when we did this we were able to operate at a point where we could engrave onto the wood while not completely burning holes in it. This is ideal for having a very versatile laser that can print onto many different types of materials.

One of the main downsides to using this laser module is that it had a focusing lens built into the controller. However, we were opting to remove this lens and instead build a lens system that will focus the beam. One of the main reasons for this is because when designing the system we were thinking about maybe making some sort of auto focusing system that would move the lens to focus the beam based on the information that the distance sensor would provide the computer. However, after attempting to design this system we realized that there was a massive amount of dispersion from the laser diode. This has led us to still using this lens to keep the beam from dispersing as quickly as it was.

6.4.4 Lens Testing

As discussed in section 6.3.3, we've varied the lenses used in the project several times throughout, and want to outline some of the main factors we work with, why we focus on them, and what constraints they affect. Overall, when we consider lenses we have to consider three main values: Effective Focal Length (EFL), Lens Diameter (R), and Lens Anti-Reflective Coatings (AR). These three factors have proven to be useful metrics for judging the performance of lenses in our system.

As a note, when we designed the lenses for the system and tested the systems, we used Zemax. However, Zemax has some issues which became immediately apparent with the first optical system, see 6.3.1. Zemax only considers beam paths you provide, meaning off-axis rays have to be programmed into Zemax, and often as a result of the assumptions made in design, the output is not a 1:1 match. This is why often our Zemax testing was light, as it was better to gain an understanding of roughly what we need to be done, and then test in the lab environment where we'd get more accurate outputs.

Overall, for our lenses the first concern we had that outweighed all others was Effective Focal Length. The lens needs to focus the light in a reasonable amount of distance, or else the Optical Path Length of the system starts to violate the constraints around the overall size of the project. Our first lens system was very simple, and had easy to mount lenses that created a diffraction limited spot size according to Zemax with little aberration, and no AR-coatings to cause issues, but this was outweighed by the fact that the lenses resulted in an optical path length of nearly 2 meters, which clearly violated our outlined specifications.

A second concern is the lens diameter, as smaller lenses often can have lowered focal length, reducing the optical path length, but become incredibly difficult to mount. The smaller the lens gets, the more a mount takes away from the smaller surface area, resulting in lowering an already low amount of light that can be focused by the system. This becomes a problem when in order for etching to occur, we need a certain threshold of the light from the laser to be focused, and an awkward mount setup combined with a small lens might prevent that, as was the case with the testing for the lenses used in 6.3.3. We can get around this issue by adding lenses, or by custom building or purchasing lens holders. The main issue this brings us is requiring more time and money to produce effectively. Working with a larger lens that fits a standard and easy to access mount is a lot easier and effective than working with a 1mm lens.

Our final metric that serves as a cause for concern is Anti-Reflective coatings. Useful, for their ability to reduce aberration, we found this to also be an issue when some AR coatings reduced the efficacy of our laser due to the wavelength we're operating at being nearer to UV than something like red light is. In the case of the 6.3.3 system, our light was reduced in magnitude by the AR coating on the lenses per each surface it encountered, resulting in lower optical power and tighter restrictions on our ability to modulate the laser effectively without causing the system to become inoperable on materials like wood.

Overall, AR is the easiest factor to correct for, as we can find a lens with similar specifications to the one we used without an AR coating on it fairly easily, as is the current plan. That said, the ability to lower optical power using an AR coating does give us options when looking at systems we can vary, as long as we plan the system with them in mind. EFL is a main issue for our system, as we need to keep the track length of the laser as low as possible, while also making the spot size occur in a stable region of the beam path, to minimize random error. EFL often comes at the expense of lens size in our experience, and creates artificial financial pressure on the design to acquire the proper, more specialized, mounting equipment.

6.5 Secondary Optical Design Test Environment

Throughout this part of the paper we will discuss the test environment that the sensing aspects of our project overcame and how exactly we tested each part of the system to make sure there were no issues within the optical sensing system. The secondary optical design includes the design of our fire detection system, distance sensing, and the secondary laser system used to map out the print.

6.5.1 Fire Detection System Test Environment

For the fire detection system testing it is very important that we have a safe environment to test this system in. The plan to test this system is by simulating smoke without creating an actual fire or any hazard. For this to be done, we will make use of a fog machine. This will put enough of a block into the air that it should trip the sensor. It is important that we get this system working given that fires can be destructive, we do not want to create a fire within our system due to this issue.

To begin with we will construct this system and run extensive testing on how quickly our fire detection system can detect our fake smoke. Most of this testing will take place outside of the senior design lab to make the testing easier. Once this is done we will transfer the system into our printer, this will be relatively easy as we will already know the system works and is functional.

Once implemented into the system we will test the fire detection one more time using fog. This will help to ensure that nothing was broken while moving the system over to the printer. From here the system will be active at all times the printer is running to ensure that no fire is started without notification of the user.

6.5.2 Distance Sensing Test Environment

For the distance sensing environment, we have been testing a lot using a breadboard, an infrared LED, and a photodetector. From here we will be using an arduino to do initial testing and calculation. This should aid in having all the calculations done before implementing the system into our final design. With the calculations done beforehand when we implement it into our design it should be relatively easy. However, if we run into issues once the system has been moved to our main microcontroller we may need to redo the testing and math to account for the issues.

6.5.3 Secondary Laser Test Environment

The secondary laser will be tested inside of the senior design lab. To make sure this system works we will attempt to use a beam combiner to combine both laser beams on top of each other. However, these lasers will never be turned on at the same time. It is very important that whenever the user is using the second laser (650 nm) the primary engraving laser (405 nm) is unable to turn on. Due to this we will have the software confirm that the 650 nm laser is powered off before turning on the powerful 405 nm

primary laser. If this system fails the user may end up looking at the beam of a class 3B laser. This is very important that it is tested accordingly and safe for operation. Next the lasers must point to the same spot on the print bed. This is important for showing the user the edges of the print so they are able to adjust the location of their print be either using the software or by moving the material to the desired location.

6.6 Secondary Optical Design Specific Testing

Throughout this section we will discuss the specific testing that was done within our optical sensing system. We will also discuss the results of this testing and what will need to be changed for our end project to work. The secondary optical design includes the design of our fire detection system, distance sensing, and the secondary laser system used to map out the print.

6.6.1 Fire Detection System Testing

The fire detection system testing will be extensive. To start we will build the circuit up and use an infrared LED and photodetector to test that we are able to detect the LED. Once this is done we will make sure these two components cannot see the other part. The electronics during the testing will be a breadboard, once we have finalized the circuit we will probably move it to a circuit board. This will be done by placing a block between the two systems. After this we will turn the circuit on and take a fog machine and see how sensitive the system is to fog. We have chosen to test using fog as it is a safe alternative to smoke that doesn't have any of the downsides that smoke has. We will need to make sure that we run tests to make sure that our system is able to see fog both very close to the photodetector as well as at the print bed. This will ensure that there is no way our system could fail. We will also be testing using different amounts of fog to see if it is possible for false positives to occur. As stated in 6.5.1 once the extensive testing has been completed the fire detection system will be moved into our printer.

6.6.2 Distance Sensing Testing

Much of the testing and math for our distance sensing has yet to be completed. This is mainly due to an issue that we ran into at the end of the semester. It came to our realization that using one infrared LED, it was difficult to get our photodiode to measure it. To deal with this issue a solution would be to build a lens system to focus the infrared light from the LED to a spot. This would also involve focusing the light from the surface of the material to the detector. Another method would be to add more infrared LEDs. This is probably what we plan to do next semester to solve this issue as it will be the cheapest and easiest to set up.

Preliminary testing has shown that this method will work and won't be super expensive. The resolution that we can get from the system will also be high enough that the results can be used to move the print plate to the focal spot of the laser.

6.6.3 Secondary Laser Testing

It should be noted most of the testing of this laser system has yet to be completed. However, the plan is to use a beam combiner and place both beams on the same spot onto the print bed. For this to occur we will start with aligning the 405 nm primary laser and making a mark on the media to reference this location. After this has been completed we plan to turn on the 650 nm secondary laser and test the location in which it hits. We will then adjust the location of this 650 nm laser to move the laser point on the print bed to the same location as the 405 nm primary laser. If we are unable to do this we will have to result to moving the optics around. Mainly the beam combiner. This will be difficult as each move on the beam combiner will move the end point of both lasers. For this reason we plan to only move this beam combiner if absolutely required and there isn't an alternative. It should also be noted that it is possible the beam combiner will not work in this case and cause too much loss for our primary laser. If this occurs we plan to mount the secondary laser outside and just have the system offset when showing the print area before starting. This however, would not look as nice and may be confusing to the user, due to this we will avoid using this mounting method.

6.7 Software Test Environment

6.7.1 Document Processing Software Test Environment

The Document Processing Software will primarily be tested in the same environment in which it was written. Development for this project will be done in a Linux environment, and rudimentary tests will continually be done throughout the process of writing the code to check for compilation errors and accuracy of functions that have been written. The Linux environment that will be used for development will be by running the latest Arch Linux distribution. However, no platform specific code will be written so the code will be expected to work on a majority of Linux distributions without flaw.

Once development of code has finished (or reached a large functional milestone - like a rudimentary GUI), testing in a Windows 11 environment will take place. This way, we can ensure that the program that's been written can easily be run by any laptop possessed by a team member.

6.7.2 MCU Firmware Test Environment

Testing the microcontroller firmware involves ensuring that the microcontroller is outputting the correct signals. This is not simply a matter of whether or not a GPIO pin outputs a logic high, but also making sure that PWM signals of the correct amplitude, duty cycle, and frequency are generated. To carry out the testing plan highlighted in section 6.8.2 below, the microcontroller is firstly going to be connected via USB to an external computer to generate input. An SD card will have to be inserted as well. The external computer does not need to be running the document processing software for

these tests to take place, so long as a terminal that supports serial communication is running.

Then, the microcontroller's output pins will be individually examined by an oscilloscope in the senior design lab. Because there will be too many pins to connect everything to the same scope at the same time, tests for each pin pairing (for example, the pins driving stepper motor #1 or 2) will be done individually. This connection can be done with a breadboard, or by connecting the oscilloscope directly to the microcontroller outputs. Power for the microcontroller will come from a power supply, also in the senior design lab.

6.8 Software Specific Testing

To test the design and functionality of the software, it is necessary to test core functionality as well as exploring any edge cases that might occur during system operation. Core functionality is the ability for the software to successfully execute the standard, simplified cases. In the case of document processing this would be testing if the software can successfully process a very small, uncomplicated image. For the MCU system, this would be testing if the MCU can successfully generate instructions for the system given a small input file. Edge cases are cases that explore extremely unlikely situations, designed to find any bugs that could appear in a seemingly random fashion late into the product development process. An example edge case would be attempting to process a document that is significantly larger than the desired output space, or attempting to open a file that does not exist.

6.8.1 Document Processing Software Testing

For the document processing software, testing can be done without any physical prototype having been constructed. The core functionality of the document processing software will be generating viable output, as well as sending said output to the MCU system. Edge cases will primarily be file format errors, any GUI glitches that occur, and communication errors between the computer and the MCU.

Because there is no exact 'correct' output for the document processing software, inspection will have to be done manually. With the custom software output that was proposed in section 3.2.2, manually inspecting the bitmap for legibility will be a simple process. The bitmap could be loaded in a text file viewer and zoomed outward to determine if the print instructions are legible or not. This process will be repeated for multiple types of images that include text, complex images, and multiple color arrangements. Testing multiple types of images will expose any flaws in the conversion process, allowing for function adjustment to get desired results.

To test the ability to send output to the MCU, it will be necessary to have the MCU system built. Testing of this functionality can simply be done by sending a file to the MCU system, removing the data storage peripheral (an SD card), and inspecting the data present. By using an SD card reader and copying the file that the MCU received to a computer running Linux, the file can be compared with the original file using the diff command. If any errors occurred in communication, the two files would be different, and

the serial line that connects the computer and the MCU can be inspected for potential flaws.

6.8.2 MCU Firmware Testing

Because the MCU firmware will be relatively modular, we need to design tests for each function of the firmware. The easiest functions to test will be the motor and laser control functions. This is because their outputs from the MCU are simple control signals, that could be visually inspected for correctness. This visual inspection can be done using an oscilloscope in the lab, or by connecting the parts with jumper wires and breadboards. The benefit of visualizing the microcontroller's output on an oscilloscope is that we would have more exact timing information, and can determine any accuracy issues that are taking place (even if the output is functionally correct). An example of an accuracy issue would be that the pulse width used to drive the stepper motor could be too short. According to the data sheet of the A4988 motor controller, the high and low sections of a pulse can be no less than 1 μ S each. On the oscilloscope, we can count the duration of the PWM signal and determine if the stepper motor would have been driven the correct amount of times for the function call.

The laser functions can be tested in the same way. By examining the PWM output with an oscilloscope, we can accurately tell if the correct signals with the correct timing are being generated. Because of the thinness of paper, the laser needs very accurate control to not burn through or scorch the material. By ensuring that the signals generated are within specifications before connecting to hardware, we remove a variable from the debugging processes during integration.

To test that data from the sensors is being read correctly, we need to have designed and built them. At the moment, we are unsure what exactly these sensors would look like. Once they are designed and built, the microcontroller's firmware can be used to read whatever data they generate and display it over its UART interface. If the data does not make any sense but is being read by the firmware, the problem most likely lies with the sensors. However, this depends on how the firmware will be reading the data. If it is as simple as receiving a voltage or binary number, we can know that any outlier data is from the sensor. But if the firmware has to make calculations, it is important to display the input data and the output data in the UART terminal. This way, the calculations can be evaluated by inspection and it can be determined if the firmware is incorrectly interpreting the data.

The UART interface can be tested by simply connecting to an external computer and testing out all input commands. A special version of the firmware can be written that will return debug prompts over UART for output that would normally be sent to the system. This way, we can view in the terminal not only whether commands are being received, but if they're being interpreted correctly. For example if we were to initiate printing with a test command, the system could send back debug prompts for every step in the printing process, like "-> Moving x-axis by ...". Through this interface, the core functionality of the entire firmware can be tested without a working prototype. The results can then be verified with individual hardware components once prototypes are ready to be connected.

7. Administrative Content

Throughout this section we will discuss a lot of the overall content that did not find other places into the report to fit. Within the section it will include topics such as milestones, budget and finance, and distribution of workload. All of this content is super important to the success of this project and keeps everyone in the group on track and focused. This also helps keep the tasks clear so everyone knows who is in charge of what section.

7.1 Milestone Discussion

During the entire course of senior design I, we formed our group. From there we worked on brainstorming a lot of ideas that everyone was interested in working on. From here we were able to divide the roles up depending on the major. This helped each of our members to work on their aspect of the project. The first version of our divide and conquer was very rough as we were unaware of the deadline being at noon. This was also due to the fact that we were brainstorming ideas up until the week the first divide and conquer was due. After we received feedback on our first report we started working on our second divide and conquer while also working on researching many of the different aspects of our project. This has helped us advance in multiple milestones at the same time. As soon as we turned in our second divide and conquer we started working on our 60-page draft. We did not need a meeting to go over our second divide and conquer and due to this it gave us extra time to focus on the 60-page paper and make sure it was good. We ended up turning in our 60-page paper as we reached the required number of pages. After we turned in our 60-page draft we started working on our 100-page draft. We ended up having our 60-page meeting 4 days after the due date of the 60-page draft, this gave us ample time to work on the 100 page draft. Some of the main feedback we received from the 60-page draft was that we needed more of the design aspect and less talk about research. Dr. Kar also spent time explaining to us the main difference between goals and objectives. This was good feedback as it gave us a focus for the 100-page draft, we were able to focus a lot more on sections 5 and 6 rather than section 3. Once we finished our 100-page draft we started work on our final document. Given the final document is due during finals week we choose to have most of the paper done before so all we have to do is any final formatting and turn it in during the week.

Milestone	Progress	Assigned To	Start Date	End Date
Form Group	Completed	All	8/23/22	8/25/22
Gather Ideas	Completed	All	8/23/22	9/2/22
Project Selection	Completed	All	9/2/22	9/13/22

Divide & Conquer 1.0	Completed	All	9/12/22	9/16/22
Divide & Conquer 2.0	Completed	All	9/12/22	9/30/22
60 Page Draft	Completed	All	9/30/22	11/4/22
100 Page Draft	Completed	All	9/12/22	11/18/22
SD1 Final Document	Completed	All	9/12/22	12/6/22
Image processing methods and algorithms	Completed	Franklin	9/20/22	10/3/22
Communication protocols	Completed	Franklin	9/20/22	10/3/22
On-board control data storage	Completed	Franklin	9/20/22	10/3/22
Mechanical movement methods	Completed	Ifran	9/20/22	10/3/22
Electrical motor control methods	Completed	Ifran	9/20/22	10/3/22
Laser head computation and research	Completed	Ethan	9/20/22	10/3/22
Laser intensity control	Completed	Ethan	9/20/22	10/3/22
Sensing methods	Completed	Sean	9/20/22	10/3/22
Safety measures	Completed	All	9/20/22	10/3/22
Power conversion and distribution calculations	Completed	Ifran	9/20/22	10/3/22

Table 14; Senior Design I Milestones

Going into senior design II, we are planning on working on certain aspects of our project a lot sooner. This is partly due to the fact that we should have the main aspects of our main optical setup done where all that will be left in the optical side will be the infrared imaging. This will help the project to stay on track as most of us will still have other classes outside of senior design II. However, most of us will have less classes than we currently have in senior design I. This means we will have significantly more time to focus on building our prototype as well as testing and troubleshooting. We are planning to have our final design done by April 20th, this should give us plenty of time to work on our final report if issues come up at the last minute.

Milestone	Progress	Assigned To	Start Date	End Date
Build Prototype	Not Started	All	1/9/23	1/30/23
Testing and Troubleshooting	Not Started	All	TBD	TBD
Finalize Design	Not Started	All	2/1/23	4/20/23
Build Finalized Design / Modify Prototype	Not Started	All	TBD	TBD
Peer Presentation	Not Started	All	TBD	TBD
Final Report	Not Started	All	TBD	TBD
Final Presentation	Not Started	All	TBD	TBD

Table 15; Senior Design 2 Milestones

7.2 Budget and Finance Discussion

The prices below are estimated prices based on our current research. The prices, quantity, and materials are subject to change once more research has been conducted. As of 11/4/22 there are no sponsors for the project and those involved will be financing the final build. Many of these parts could change in price as well as quantity. It should be noted that because we haven't started prototyping many aspects of our project that we may need to make bigger changes to what we are currently projecting to buy. We also could end up not needing certain parts. As we begin to build and design our final project we will know more about our final projected cost.

Material	Unit Cost	Quantity	Total Cost
Optical Components			
405 nm Laser	\$50	1	\$50
Laser Mount	\$20	1	\$20
LEDs	\$10	1	\$10
Detectors	\$10	1	\$10
Lens	\$40	2	\$80
Beam combiner	\$150	1	\$150

650 nm Laser Pointer	\$10	1	\$10
Laser warning Label	\$5	1	\$5
Electrical Components			
Stepper Motors	\$15	2	\$30
AC Adapter Power Supply	\$20	1	\$20
Motor Controllers	\$4	2	\$8
Custom PCB	\$20	1	\$20
Miscellaneous PCB Components	\$10-20	1	\$10-\$20
Display	\$20	1	\$20
DC Fans	\$5	3	\$15
Computer Components			
Microcontroller or Microprocessor	\$30	1	\$30
Building materials			
Aluminum rails	\$10	10	\$100
3D printer filament	\$20	1	\$20
Paper	\$4	1	\$4
Wood	\$50	1	\$50
Miscellaneous	\$30	1	\$30
Total Cost Estimate			\$692-702

Table 16; Estimated project budget

7.3 Distribution of Work

We wanted to divide the work up evenly. Distributing the work evenly really helps with large projects so no one person is stuck doing the majority of the project and leaving the other people behind. It has helped us stay on track and keep everyone accountable for their section of the project. For us to accomplish this we focused on

creating a block diagram to keep track of each of the main systems of the project and where each person is currently on that part. This made it easy for us to quickly see who was in charge of each part of the project and see how far along they are in that process. We also went over these in our weekly meetings to make sure everyone was making progress on the overall project and not procrastinating it till the very end. This helped as we could see what parts of the project were falling behind during the meetings and discuss how to be able to catch it back up and get it back on track. When one person fell behind and if they needed help catching back up we were all able and willing to jump in and help them. This is mainly due to the fact that we all know how important this project is and meeting the overall requirements. The current block diagram for the project can be seen in figure 21, including a color-coded legend that shows which team members are responsible for which sub-systems.

8. Conclusion

In designing the D-MILE, we've gone through several unique iterations of design. At first the project scope was solely on producing a laser printer for A4 paper that didn't use ink or toner to print the text. However, as research was performed and the project was developed we discovered that in terms of design, we would struggle to make full use of our optical engineers, and so wanted to expand the scope of the system. That resulted in a wide array of subsystems that could be fitted into the design, none of which had any great sense of cohesion with one another or multitasking potential, which resulted in more stress and strain on other core goals.

Another aspect of the project worth deliberating on is the changes in focus, as originally the material of choice was A4 paper due to its abundance and ubiquitous nature in the domain of printing, and though we were able to get it working properly with an output we liked, we decided to transition to focusing on wood etching, which far increased the kinds of outputs we could produce, allowing us to focus more on expanding the limits of our optical design.

At the time of writing, our project is in a good state. The primary optical design for the printer, the laser itself, is functioning as we'd expect and has room for improvement still, even while functioning well within the original goals of the project. This leaves us more room to focus on the secondary optical systems, while also making final improvements to the optics of the laser focus system.

Research has been done onto what is needed for the mechanical side of things, as well as the beginning of programming the firmware the printer would need to run. Our main concerns at the moment stem from the mechanical side of the project, but if time starts to run out, or it seems to difficult, we plan on acquiring a 3D printer or similar device, replacing the filament system with our laser system, and reworking the programming to run our firmware and drive the pre-built motor system due to the lack of a mechanical engineering in the team.

9. References

List of Tables

1. Requirements
2. Software comparison chart
3. ATmega family device comparison
4. MSP430 device comparison
5. STM32 device comparison
6. Pros and Cons of using a Stepper Motor
7. Comparing Stepper Motors and Servo Motors
8. Threaded Rod vs Timing Belt design
9. Comparisons and examples of IPC Product Classes
10. Materials that cannot be cut or engraved due to hazards
11. Notable materials for engraving
12. Uncuttable materials that can be engraved
13. Trade Offs for Design Options
14. Senior Design 1 Milestones
15. Senior Design 2 Milestones
16. Estimated project budget

List of Figures

1. Preliminary SolidWorks Design for the D-MILE system
2. House of Quality
3. Subsystem block diagram and distribution of work
4. Rasterization example from ScratchAPixel
5. Output we are hoping to achieve
6. Decision diagram for software development
7. Gaussian, Flat Top, and Top-Hat beam profiles
8. Gaussian, Flat Top, and Top-Hat beam profiles
9. Intensity Graph of the Gaussian beam profile that will be used in our system
10. How an optical fire alarm works
11. Time-of-Flight System Basics
12. The Nema 17 Stepper motor that will be used in our design, for both X and Y axis movement of the laser diode.
13. Conjoined Independently Driven Axis configuration for timing belts (left) and threaded rods (right)
14. Core-XY belt configuration (left) and H-Bot belt configuration (right)
15. Tension forces (green) and Belt direction (blue) for Core-XY and H-Bot configurations when moving along the positive X-axis

16. 3D model of what D-MILE may look like
17. IPC-2221 Sub-Standards Hierarchy Flowchart
18. Lens design
19. Schematic of how a fire safety system could be designed for our system
20. Diagram of how the time of flight method would work
21. Optical Workspace Detection System mounting option 1
22. Optical Workspace Detection System mounting option 2
23. Example of how the system may move along the dotted lines to each corner
24. High-Level Design Flowchart
25. Voltage Divider Regulator schematic and transient simulation, variable voltage output and 0-20mA load range
26. Zener Regulator schematic and transient simulation, 12V output and 0-20mA load range
27. LM317 Adjustable Regulator output schematic and transient simulation, 12V output and 0-3A load range
28. LM2576 Adjustable Switching Regulator schematic and transient simulation, 12V output and 0-10A load range
29. 20mA LED on 12V switching regulator output, transient simulation showing both LED current and output voltage
30. Flowchart of general firmware components and program flow
31. Printing process in MCU firmware
32. Original grayscale image compared with conversion using global threshold and selective thresholds, respectively
33. GUI rendering
34. LM317 Adjustable Regulator prototype with 12V output
35. LM2576 Adjustable regulator with 12V output
36. Schematic of the laser setup for the first demo
37. Laser setup that was used for the first demo
38. Lens design that Zemax calculated
39. Spot size that Zemax calculated with the an analysis of the results
40. Zemax Seidel Diagram
41. Laser diode controller schematic that was used in the second demo
42. Example Outputs from November 15, 2022
43. Laser diode diameter
44. Seidel Diagram for the Second Demo Lens System
45. Spot Sizes for Ideal Resolution and Airy for On and Off-Axis Rays
46. Beam Path for On and Off-Axis Rays for Final System
47. Final Seidel Diagram
48. Final Beam Spot Patterns for On and Off-Axis Rays
49. Laser Demo Setup
50. Function Generator Settings

Appendix A - References

Note: The reference numbers is in no particular order

Reference Number	Reference
[1]	Why Use a Flat Top Laser Beam? From Edmund Optics https://www.edmundoptics.com/knowledge-center/application-notes/optics/why-use-a-flat-top-laser-beam/
[2]	ImageMagick https://imagemagick.org/index.php
[3]	RasterCarve https://github.com/built1n/rastercarve
[4]	LaserGRBL https://github.com/arkypita/LaserGRBL
[5]	GRBL https://github.com/grbl/grbl
[6]	Wikipedia G-code https://en.wikipedia.org/wiki/G-code
[7]	TI-Microcontrollers-mcus-processors-microcontrollers-msp430 https://www.ti.com/microcontrollers-mcus-processors/microcontrollers/msp430-microcontrollers/overview.html
[8]	FOBA Laser Engraving Machines https://page.fobalaser.com/en_ga_Laser-Engraving-Machine.html?utm_source=google&utm_term=laser%20etching%20machine&matchtype=p&utm_campaign=US-Lasergravurmaschine_n&gclid=Cj0KCQjwqoibBhDUARIsAH2OpWhgs5K1hd4oA9D6YHTBSUc3UWI_nX-z1fa9Gfh5xqXQo0wd1R90E3waApLGEALw_wcB
[9]	Wikipedia SD card https://en.wikipedia.org/wiki/SD_card#SD_(SDSC)
[10]	Wikipedia I ² C https://en.wikipedia.org/wiki/I%C2%B2C
[11]	Understanding the I ² C Bus by Jonathan Valdez, Jared Becker https://www.ti.com/lit/slva704
[12]	Rasterization: a Practical Implementation https://www.scratchapixel.com/lessons/3d-basic-rendering/rasterization-practical-implementation/rasterization-stage

[13]	The Best Laser Printer by Ben Keogh, (2022) https://www.nytimes.com/wirecutter/reviews/best-laser-printer/
[14]	LM2576xx Series SIMPLE SWITCHER® 3-A Step-Down Voltage Regulator https://www.ti.com/document-viewer/LM2576/datasheet/GUID-C8FD739A-033A-4FDF-AEEA-A719DFB4FE1D#TITLE-SNVS107SNVS1076474
[15]	LM317 3-Terminal Adjustable Regulator https://www.ti.com/document-viewer/LM317/datasheet/features-sces1289655#SCES1289655
[16]	Mainstream Arm Cortex-M0+ 32-bit MCU, up to 256KB Flash, 144KB RAM, 6x USART, timers, ADC, DAC, comm. I/Fs, 1.7-3.6V https://www.st.com/en/microcontrollers-microprocessors/stm32g0b1vc.html#overview
[17]	Generic Standard on Printed Board Design https://www.ipc.org/TOC/IPC-2221B.pdf
[18]	Never Cut these Materials https://cpl.org/wp-content/uploads/NEVER-CUT-THESE-MATERIALS.pdf
[19]	What Is a Photoelectric Smoke Detector https://www.x-sense.com/blogs/tips/what-is-a-photoelectric-smoke-detector
[20]	Trotec Laser Application Personalization https://www.troteclaser.com/en-us/laser-applications/personalization
[21]	ATmega328p MCU https://www.microchip.com/en-us/product/ATMEGA328P
[22]	ATmega2560 MCU https://www.microchip.com/en-us/product/ATmega2560
[23]	ATmega 4809 MCU https://www.microchip.com/en-us/products/microcontrollers-and-microprocessors/8-bit-mcus/avr-mcus/atmega4809
[24]	MSP430 MCU Family https://www.ti.com/microcontrollers-mcus-processors/microcontrollers/msp430-microcontrollers/overview.html

[25]	STM32G0 Series MCU Family https://www.st.com/en/microcontrollers-microprocessors/stm32g0-series.html
[26]	STM32F4 Series MCU Family https://www.st.com/en/microcontrollers-microprocessors/stm32f4-series.html
[27]	A4988 Stepper Motor Controller https://www.alldatasheet.com/datasheet-pdf/pdf/338780/ALLERGRO/A4988.html

Appendix B - Permissions

[1] Fair Use of Images From Edmund Optics
Transcript discussion with Customer Service reads:



Chat transcript

First Name: Ethan
Last Name: Teodosio
E-mail: cehahte@gmail.com

Is your application military/defense related or potentially dual-use? A "dual-use" item is one that has civil applications as well as military/WMD-related applications. No
Does your application include items that are under Export Control? No
Choose a department: Customer Service

We will use this information to provide you with technical support via chat session and will retain this information for auditing purposes pursuant to GDPR. You can view our full privacy policy on the Edmund Optics website. I agree

Lisa Mon, 12/05/22 10:09:23 pm America/New_York
Hello Ethan. How may I help you?

Ethan 10:09:57 pm
Hello. I'm working on a Senior Design project in my university, and I was wondering if I'm allowed to reference/cite material in the Learn section of your website.

Lisa 10:11:22 pm
You mean you need to include information from our application notes in your project paper?

Ethan 10:11:32 pm
<https://www.edmundoptics.com/knowledge-center/application-notes/optics/why-use-a-flat-top-laser-beam/>
This page, specifically.
It was just the resource I found explaining the concept behind Flat Top versus Gaussian beams.
So its not product related.
But I wasn't sure if its okay to use the visuals in that page while citing them appropriately. I'm not sure if you have a Fair Use page or anything going over what can and cannot be cited/referenced.

Lisa 10:12:59 pm
You can reference this, no problem.

[3] Copyright License for RasterCarve

```
GNU GENERAL PUBLIC LICENSE
Version 2, June 1991

Copyright (C) 1989, 1991 Free Software Foundation, Inc.
59 Temple Place, Suite 330, Boston, MA 02111-1307 USA
Everyone is permitted to copy and distribute verbatim copies
of this license document, but changing it is not allowed.
```

[4] Copyright Notice for LaserGRBL

```
COPYRIGHT NOTICE FOR LaserGRBL:

LaserGRBL - Laser optimized GUI for Grbl

Copyright (c) 2016 Diego Settimi

LaserGRBL is free software: you can redistribute it and/or modify it under the terms of the GNU General Public License as published by the Free Software Foundation, either version 3 of the License, or (at your option) any later version.

LaserGRBL is distributed in the hope that it will be useful, but WITHOUT ANY WARRANTY; without even the implied warranty of MERCHANTABILITY or FITNESS FOR A PARTICULAR PURPOSE. See the GNU General Public License for more details.

You should have received a copy of the GNU General Public License along with Grbl. If not, see http://www.gnu.org/licenses/.
```

[5] Copyright Notice for GRBL

```
Grbl - Embedded CNC g-code interpreter and motion-controller

Copyright (c) 2011-2015 Sungeun K. Jeon
Copyright (c) 2009-2011 Simen Svale Skogsrud
Copyright (c) 2011 Jens Geisler

Grbl is free software: you can redistribute it and/or modify
it under the terms of the GNU General Public License as published by
the Free Software Foundation, either version 3 of the License, or
(at your option) any later version.

Grbl is distributed in the hope that it will be useful,
but WITHOUT ANY WARRANTY; without even the implied warranty of
MERCHANTABILITY or FITNESS FOR A PARTICULAR PURPOSE. See the
GNU General Public License for more details.

You should have received a copy of the GNU General Public License
along with Grbl. If not, see <http://www.gnu.org/licenses/>.
```

[6, 9, 10] Copyright on Wikipedia

Full note reads: “The Wikimedia Foundation does not own copyright on Wikipedia article texts or illustrations. It is therefore pointless to email our contact addresses asking for permission to reproduce articles or images, even if rules at your company, school, or organization mandate that you ask web site operators before copying their content.

The only Wikipedia content you should contact the Wikimedia Foundation about are the trademarked Wikipedia/Wikimedia logos, which are not freely usable without permission.

Permission to reproduce and modify text on Wikipedia has already been granted to anyone anywhere by the authors of individual articles as long as such reproduction and modification complies with licensing terms (see below and Wikipedia:Mirrors and forks for specific terms). Images may or may not permit reuse and modification; the conditions for reproduction of each image should be individually checked. The only exceptions are those cases in which editors have violated Wikipedia policy by uploading copyrighted material without authorization, or with copyright licensing terms which are incompatible with those Wikipedia authors have applied to the rest of Wikipedia content. While such material is present on Wikipedia (before it is detected and removed), it will be a copyright violation to copy it. For permission to use it, one must contact the owner of the copyright of the text or illustration in question; often, but not always, this will be the original author.

If you wish to reuse content from Wikipedia, first read the Reusers' rights and obligations section. You should then read the Creative Commons Attribution-ShareAlike 3.0 Unported License and the GNU Free Documentation License.”

[7, 11, 14, 15, 24] Terms of Use for ti.com

Terms of Use reads: “These terms of use (TOU) apply to all customers, visitors, and other persons or entities that use or access TI.com. Your access to and use of TI.com is subject to these TOU and all applicable laws. Unless prompted otherwise, by accessing or using any part of TI.com, you acknowledge that you have read and understand the following terms and you accept, without limitation or qualification, to be bound by them.”

[12] Creative Commons license for Scratchapixel

As stated at bottom of page: “This website and its content is copyright of Scratchapixel. This work is licensed under a Creative Commons Attribution 4.0 International License”

[16, 25, 26] Terms of Use for ST Microelectronics

As stated in their Terms of Use: “ST provides this website to you, subject to these Terms of Use for the website and other websites that are operated and/or controlled by ST or that are affiliated or linked with this site (collectively “the ST Sites”) and all the information, communications, drawings, photos, text, and other materials and services found on the ST Sites (collectively “Materials”), is intended for the lawful use of ST’s customers, and those authorized employees of ST’s customers. All rights and licenses granted to you hereunder are personal to you and shall not include any right to grant sublicenses to any third party except as maybe expressly set forth herein.”

[17] Copyright Information/User Rights from IPC

As stated in Web Site Notices and Disclaimers: “As a user, you are authorized only to view, copy, print, and distribute documents on this Web site so long as (1) the document is used for informational purposes only, and (2) any copy of the document (or portion thereof) includes the following copyright notice: Copyright © IPC. All rights reserved.”

[19] X-sense Copyright

Bottom of the page states: “Copyright © 2022 X-Sense. All Rights Reserved”

[21, 22] Microchip Copyright

As stated under Microchip Copyrighted page: “If you use Microchip copyrighted material solely for educational (non-profit) purposes falling under the “fair use” exception of the U.S. Copyright Act of 1976 then you do not need Microchip’s written permission. For example, Microchip’s permission is not required when using copyrighted material in: (1) an academic report, thesis, or dissertation; (2) classroom handouts or textbook; or (3) a presentation or article that is solely educational in nature (e.g., technical article published in a magazine). Please note that offering Microchip copyrighted material at a trade show or industry conference for the purpose of promoting product sales does require Microchip’s permission.”